



HYDPOWER
HOSE & FITTINGS

PRODUCT CATALOGUE - 2020



TRUSTED | PROGRESSIVE | PROVEN

RAISING THE BAR TO REDUCE YOUR PRESSURE AND COST

The Innovative B2B Wholesale Supply
Design & Performance Specialists



CLIENT FOCUSED PROGRAMS | OUR POINTS OF DIFFERENCE

ADVANTAGE REWARDS™

EARN POINTS
redeemable against
in store credits,
rebate scheme or
comprehensive range
of gift cards

RISK FREE TRADING™

24 MONTH
Industry leading
no risk component
guarantee on all
specified items

HYDPOWER CHALLENGE™

FREE OF CHARGE
challenge for us to
review & find hydraulic
cost savings and
performance
improvements



TRUSTED | PROGRESSIVE | PROVEN

HYDPOWER hydraulics is one of Australia's leading low cost, full-service providers

With over 40 years of practical hands on experience, we have established ourselves as a credible trusted and strategic partner to many companies requiring hydraulic systems, components and engineering services

OUR PROGRESSIVE APPROACH ENSURES YOU GET THE VERY BEST:

- Competitive prices on all components
- 24 Month Risk Free Warranty
- Rewards program saving you money on purchases
- High quality and durable components
- Free technical support, unbiased advice and guidance

HYDPOWER'S PROVEN TRACK RECORD ALLOWS US TO BE CONFIDENT IN OUR DEALINGS WITH YOU

We are willing and able to lend a helping hand whenever you need us for :

- End to End System Design
- Component selection and supply
- Installation
- Commissioning
- Testing and troubleshooting
- Performance improvement
- System enhancement

OUR DIVERSE HYDRAULIC EXPERIENCE INCLUDES:

- Industrial
- Agricultural
- Construction
- Transport
- Bulk-Handling
- Recycling
- Manufacturing
- Marine

To find out how you partner with us completely risk free, visit us at hydpower.com.au

We look forward to adding value to your business soon

HOSES | HOSE END FITTINGS AND ADAPTORS



Unlike most hydraulic component suppliers, **HYDPOWER** offers a comprehensive range of high quality hoses, hose end fittings, adaptors and accessories at very competitive prices

Hoses, hose end fittings and adaptors have been strategically implemented into our business to compliment our component and design services, to provide total ownership and guarantee the best possible performance and outcomes of your hydraulic system.

In our view, it is much better to fully specify the components together simultaneously with the hose and fittings to achieve optimum system performance and reliability. Regrettably, this is a short coming within the broader hydraulics industry and a challenge for manufacturers and consumers to navigate. **HYDPOWER** takes the guess work out of this sensitive area and will assist you in selecting and specifying all of your hoses, hose end fittings and adaptors. This process will ensure that you achieve the best performance from your Hydraulics Systems.

Whether you are after a single wire, two wire, multi spiral, suction or return hose, look no further than **HYDPOWER**. Our super high quality hoses are manufactured to exceed all global hydraulic standards – thus ensuring it will provide you with reliability and long service life.

CUSTOM BRANDING / LABELING

If you are a volume hose user, please talk to us about custom branding for your brand or product to be applied to your hydraulic hose. *Note: Minimum ordering quantities apply*

WE OFFER A FREE *

No obligation review and written report of your current hoses, hose end fittings and adaptors usage and/or requirements that has been specially designed to achieve the following:

- ★ Specification of correct hose, end fittings and adaptor types and sizes
- ★ Maximise efficiency / reduce losses and overheating
- ★ Improve performance / oil flow paths
- ★ Ensure correct oil operating conditions and line speeds
- ★ Minimise connections and potential oil leaks

* Conditions apply, see website

TABLE OF CONTENTS

HOSES

PAGE 5

One Wire Smooth Coat Standard Hose	8	Two Wire Texture Coat Standard Hose	9
One Wire Smooth Coat Compact Hose	8	Four Wire Spiral 4SP Hose	10
One Wire Texture Coat Standard Hose	8	Four Wire Spiral 4SH Hose.....	10
Two Wire Smooth Coat Standard Hose	9	Suction R4 Hose	10
Two Wire Smooth Coat Compact Hose	9		

HOSE ENDS

PAGE 11

JIC Female Swivel Straight	14	BSPP Female Swivel Straight	18
JIC Female Swivel 90° Compact Elbow	14	BSPP Male Straight	18
JIC Female Swivel 90° Swept Elbow	15	BSPT Male Straight	19
JIC Female Swivel 90° Long Drop Elbow	15	BSPP Female Swivel 90° Compact Elbow	19
JIC Female Swivel 45° Swept Elbow	16	BSPP Female Swivel 90° Swept Elbow	20
JIC Male Straight	16	BSPP Female Swivel 45° Swept Elbow.....	20

ADAPTORS

PAGE 23

Straight Male x Male	24	Reducing Bush	48
Straight Male x Female	30	Run Tee	51
Straight Female x Female	33	Branch Tee	53
90° Male x Male	36	Equal Tee	55
90° Male x Female	40	BulkHead.....	58
90° Female x Female	43	Nut & Sleeve	59
45° Male x Male	45	Plugs	59
45° Male x Female	47		

ACCESSORIES

PAGE 63

Quick Release Couplings	68	Seals	72
Tube Clamps	70	Rings	73

FULL RANGE

PAGE 75

Hose Tails	76	Adaptors	80
------------------	----	----------------	----

TECHNICAL INFO

PAGE 91

Quick Conversion Table	92	Assembly Length & Angular Orientation	95
Pressure Drop Chart	93	Connector Pressure Tables	96
Fluid Nomograph	94	Crimp Charts	98

ALL IN ONE KITTING PROGRAM

If production of machines is your business, then our **HYDPOWER 'ALL IN 1' Kitting Program** is just the thing for you

We work with you to establish your particular needs – then review and document your systems to provide you with the best performance and cost saving changes.

Once identified, we can provide you with a simple re-order process with one part number covering every item that makes up each of your complete set of hoses and adaptors. This time saving initiative is just one of the many ways we are able to help your business operate more efficiently.

BUILD YOUR PROGRAM

Alternatively, if you prefer to make up your own hose assemblies, our hoses can be simply sold by the metre or a full reel. The hose end fittings and adaptors can be reordered on a monthly or weekly Kanban System to ensure you have the stock you require – the choice is entirely yours.

STORAGE SYSTEM

We offer a flexible storage system to help you keep all of your hose ends & adaptors neatly organised in labelled bins. This great mobile unit can be wheeled to just about any position in your workshop close to where your product assembly area is. Once your stock get low, simply re-order using our **new online business to business portal**. Contact us today for further information.

CRIMPING MACHINES AND DIAMOND CUT OFF SAWS

We can also supply an extensive range of **HYDCRIMP**- Crimping Machines and Diamond Cut Off Saws to suit your business and budget.

Components, Hose and Fittings all under one roof and just a call away. Contact **HYDPOWER** today for all of your hydraulic needs.



HOSES

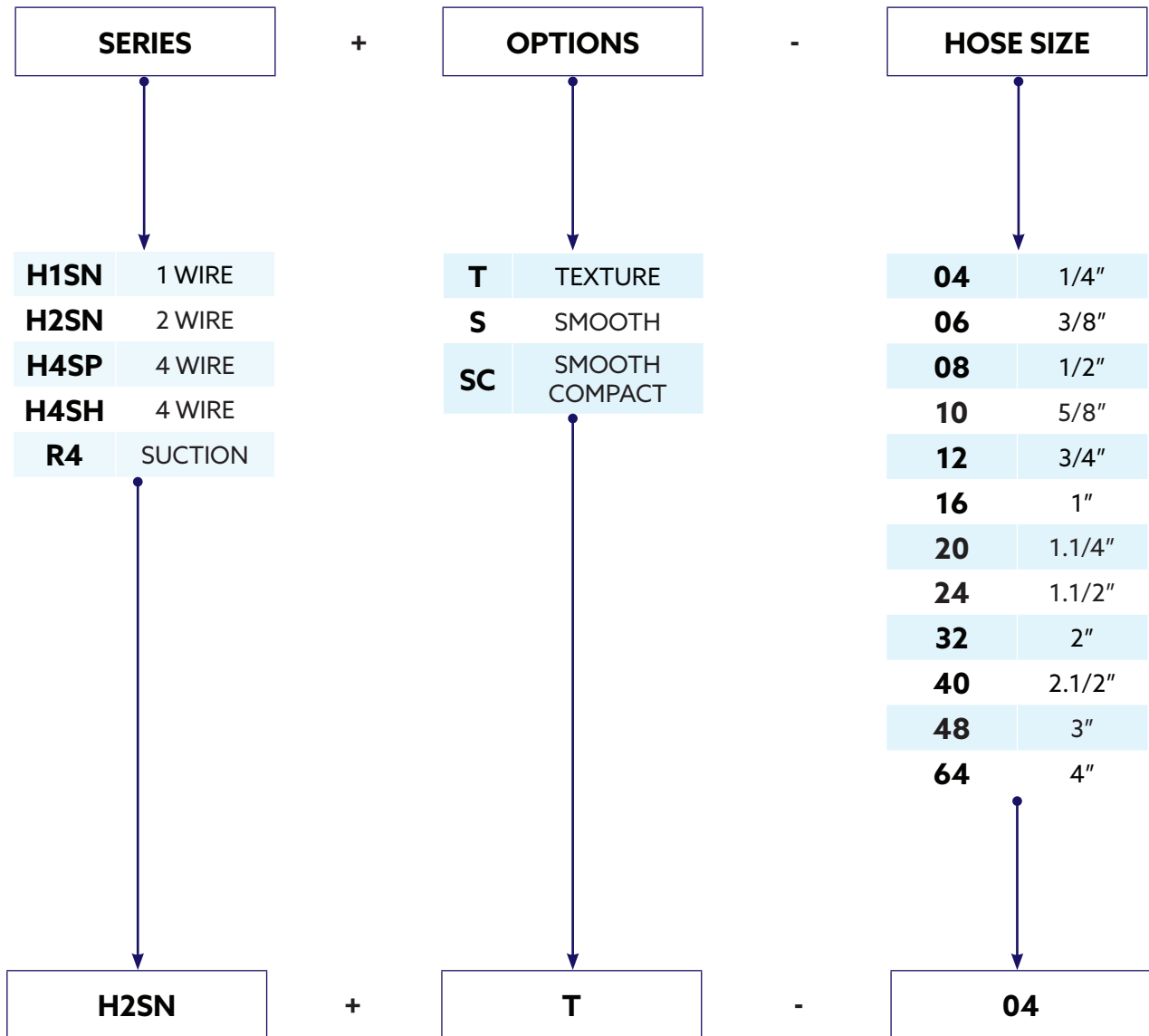

EXAMPLE
H2SNT-04
HOSE TWO WIRE
 Texture coat, 1/4 Hose

**ONE WIRE
SMOOTH COAT STANDARD**



Page 8

**ONE WIRE
SMOOTH COAT COMPACT**



Page 8

**ONE WIRE
TEXTURE COAT STANDARD**



Page 8

**TWO WIRE
SMOOTH COAT STANDARD**



Page 9

**TWO WIRE
SMOOTH COAT COMPACT**



Page 9

**TWO WIRE
TEXTURE COAT STANDARD**



Page 9

**FOUR WIRE
4SP HOSE**



Page 10

**FOUR WIRE
4SH HOSE**



Page 10

**SUCTION
R4 HOSE**



Page 10

For other hoses please contact us

HYDRAULIC HOSE - 1 WIRE

Smooth Coat - Standard

Specifications: SAE 100R1AT & EN853 1SN / DIN

Tube: Black NBR (Nitrile) synthetic rubber

Reinforcement: One braid of high tensile steel wire

Cover: Black oil and abrasion resistant synthetic rubber

Temperature Range: -40° C to +100° C



Part Number	Size	WP PSI	Max WP Bar	Coil Length (M)	List Price (P/M) (\$)
H1SNS-04	1/4"	3275	225	POA	POA
H1SNS-06	3/8"	2600	180	POA	POA
H1SNS-08	1/2"	2325	160	POA	POA
H1SNS-10	5/8"	1850	130	POA	POA
H1SNS-12	3/4"	1525	105	POA	POA
H1SNS-16	1"	1275	88	POA	POA

HYDRAULIC HOSE - 1 WIRE

Smooth Coat - Compact

Specifications: SAE 100 R1AT & EN853 1SN / DIN

Tube: Black NBR (Nitrile) synthetic rubber

Reinforcement: One braid of high tensile steel wire

Cover: Black oil and abrasion resistant synthetic rubber

Temperature Range: -40° C to +100° C



Part Number	Size	WP PSI	Max WP Bar	Coil Length (M)	List Price (P/M) (\$)
H1SNSC-04	1/4"	3275	225	POA	POA
H1SNSC-06	3/8"	2600	180	POA	POA
H1SNSC-08	1/2"	2325	160	POA	POA
H1SNSC-10	5/8"	1850	130	POA	POA
H1SNSC-12	3/4"	1525	105	POA	POA
H1SNSC-16	1"	1275	88	POA	POA

HYDRAULIC HOSE - 1 WIRE

Texture Coat - Standard

Specifications: SAE 100 R1AT & EN853 1SN / DIN

Tube: Black NBR (Nitrile) synthetic rubber

Reinforcement: One braid of high tensile steel wire

Cover: Black oil and abrasion resistant synthetic rubber

Temperature Range: -40° C to +100° C



Part Number	Size	WP PSI	Max WP Bar	Coil Length (M)	List Price (P/M) (\$)
H1SNT-04	1/4"	3275	225	POA	POA
H1SNT-06	3/8"	2600	180	POA	POA
H1SNT-08	1/2"	2325	160	POA	POA
H1SNT-10	5/8"	1900	130	POA	POA
H1SNT-12	3/4"	1525	105	POA	POA
H1SNT-16	1"	1275	88	POA	POA
H1SNT-20	1.1/4"	925	63	POA	POA
H1SNT-24	1.1/2"	725	50	POA	POA
H1SNT-32	2"	600	40	POA	POA

HYDRAULIC HOSE - 2 WIRE

Smooth Coat - Standard

Specifications: SAE 100 R2AT & EN853 2SN / DIN

Tube: Black NBR (Nitrile) synthetic rubber

Reinforcement: Two braids of high tensile steel wire

Cover: Black oil and abrasion resistant synthetic rubber

Temperature Range: -40° C to +100° C



Part Number	Size	WP PSI	Max WP Bar	Coil Length (M)	List Price (P/M) (\$)
H2SNS-04	1/4"	5800	400	50/100	13.94
H2SNS-06	3/8"	4785	330	50/100	15.94
H2SNS-08	1/2"	4000	275	50/100	17.94
H2SNS-10	5/8"	3625	250	50/100	19.94
H2SNS-12	3/4"	3100	215	50/100	23.94
H2SNS-16	1"	2400	165	50/100	33.94

HYDRAULIC HOSE - 2 WIRE

Smooth Coat - Compact

Specifications: SAE 100 R16 & EN857 2SC / DIN

Tube: Black NBR (Nitrile) synthetic rubber

Reinforcement: Two braids of high tensile steel wire

Cover: Black oil and abrasion resistant synthetic rubber

Temperature Range: -40° C to +100° C



Part Number	Size	WP PSI	Max WP Bar	Coil Length (M)	List Price (P/M) (\$)
H2SNSC-04	1/4"	5800	400	50/100	15.94
H2SNSC-06	3/8"	4785	330	50/100	17.94
H2SNSC-08	1/2"	4000	275	50/100	19.94
H2SNSC-10	5/8"	3685	250	POA	POA
H2SNSC-12	3/4"	3100	215	POA	POA
H2SNSC-16	1"	2400	165	POA	POA

HYDRAULIC HOSE - 2 WIRE

Texture Coat - Standard

Specifications: SAE 100 R2AT & EN853 2SN / DIN

Tube: Black NBR (Nitrile) synthetic rubber

Reinforcement: Two braids of high tensile steel wire

Cover: Black oil and abrasion resistant synthetic rubber

Temperature Range: -40° C to +100° C



Part Number	Size	WP PSI	Max WP Bar	Coil Length (M)	List Price (P/M) (\$)
H2SNT-04	1/4"	5800	400	POA	POA
H2SNT-06	3/8"	4785	330	POA	POA
H2SNT-08	1/2"	4000	275	POA	POA
H2SNT-10	5/8"	3685	250	POA	POA
H2SNT-12	3/4"	3100	215	POA	POA
H2SNT-16	1"	2400	165	POA	POA
H2SNT-20	1.1/4"	1825	125	50/100	62.94
H2SNT-24	1.1/2"	1300	90	50/100	88.94
H2SNT-32	2"	1175	80	50/100	99.84

HYDRAULIC HOSE - 4 WIRE

Spiral - 4SP

Specifications: SAE 100R10 - EN 856 4SP

Tube: Black NBR (Nitrile) synthetic rubber

Reinforcement: Four spiral layers high tensile steel wire

Cover: Black oil and abrasion resistant synthetic rubber

Temperature Range: -40° C to +100° C



Part Number	Size	WP PSI	Max WP Bar	Coil Length (M)	List Price (P/M) (\$)
H4SPT-08	1/2"	6000	415	POA	POA
H4SPT-10	5/8"	5000	350	POA	POA
H4SPT-12	3/4"	5000	350	POA	POA
H4SPT-16	1"	4000	280	POA	POA
H4SPT-20	1.1/4"	3000	210	POA	POA
H4SPT-24	1.1/2"	2680	185	POA	POA
H4SPT-32	2"	2390	165	POA	POA

HYDRAULIC HOSE - 4 WIRE

Spiral - 4SH

Specifications: SAE 100R10 - EN 856 4SH

Tube: Black NBR (Nitrile) synthetic rubber

Reinforcement: Four spiral layers high tensile steel wire

Cover: Black oil and abrasion resistant synthetic rubber

Temperature Range: -40° C to +100° C



Part Number	Size	WP PSI	Max WP Bar	Coil Length (M)	List Price (P/M) (\$)
H4SHT-12	3/4"	6090	420	POA	POA
H4SHT-16	1"	5510	380	POA	POA
H4SHT-20	1.1/4"	4700	325	POA	POA
H4SHT-24	1.1/2"	4200	290	POA	POA
H4SHT-32	2"	3600	250	POA	POA

HYDRAULIC HOSE - SUCTION

R4

Specifications: SAE 100R4

Tube: Black NBR (Nitrile) synthetic rubber

Reinforcement: High tensile textile cords with embedded steel helix wire

Cover: Black oil and abrasion resistant synthetic rubber

Temperature Range: -40° C to +100° C



Part Number	Size	WP PSI	Max WP Bar	Coil Length (M)	List Price (P/M) (\$)
H4SHT-12	3/4"	300	21	POA	POA
H4SHT-16	1"	250	17	POA	POA
H4SHT-20	1.1/4"	200	14	POA	POA
H4SHT-24	1.1/2"	150	10.5	POA	POA
H4SHT-32	2"	100	7	POA	POA

HOSE ENDS

CODING SYSTEM

Hose Ends

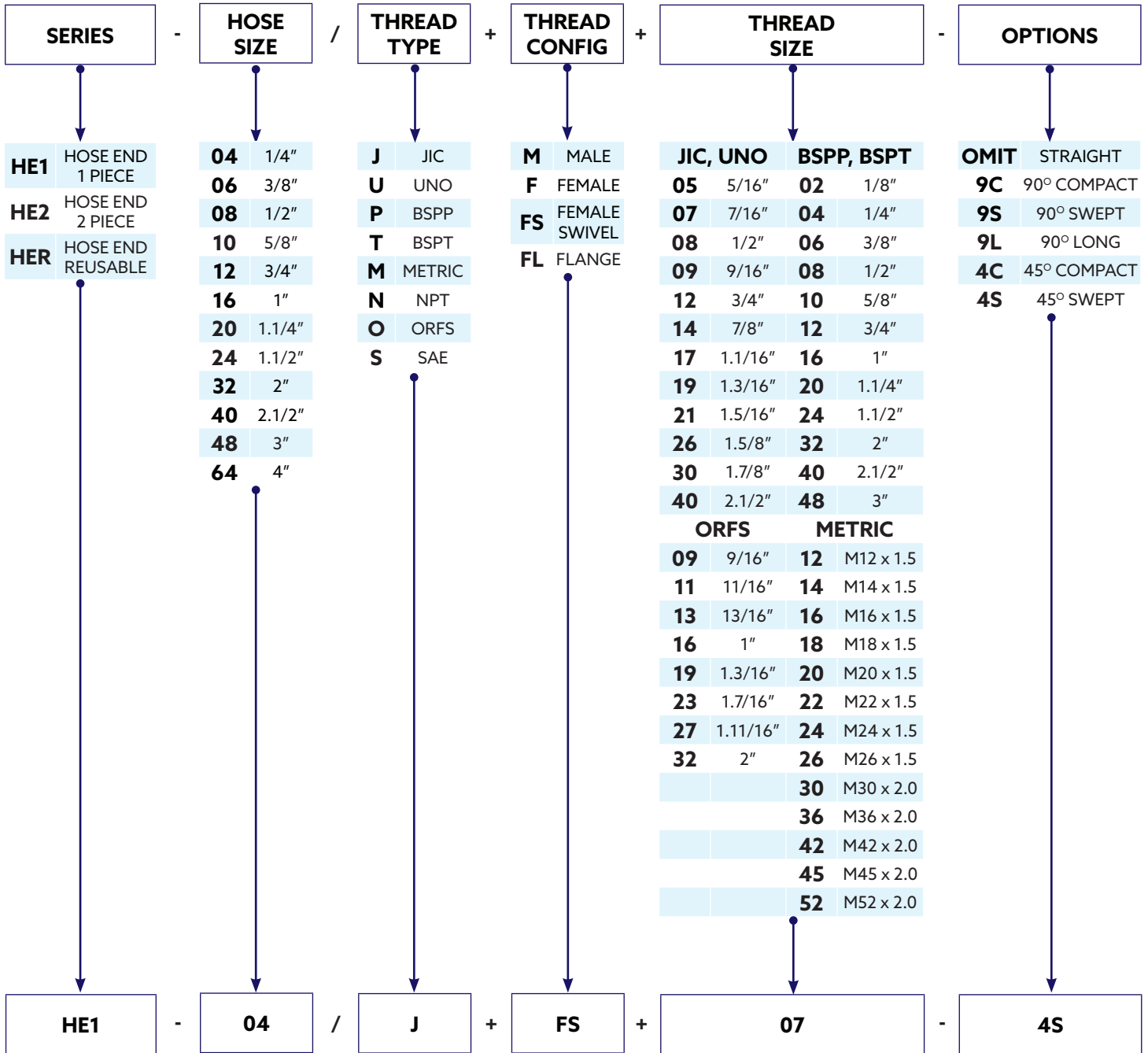

Example
HE1-04/JFS07-4S
ONE PIECE - 1/4" Hose, JIC Female Swivel 45° Swept Elbow

JIC FEMALE SWIVEL
STRAIGHT

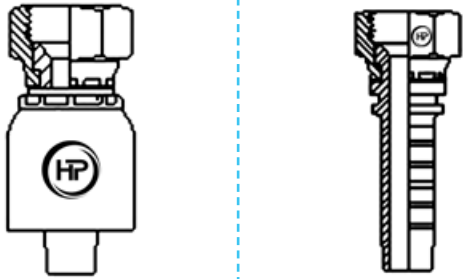

Page 14

JIC FEMALE SWIVEL
90° COMPACT

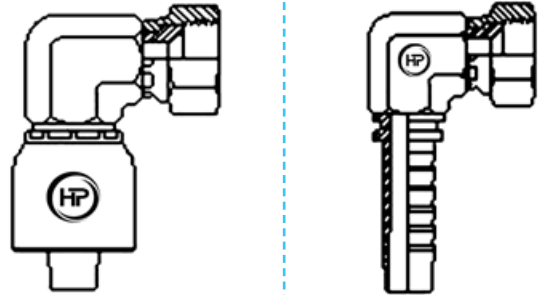

Page 14

JIC FEMALE SWIVEL
90° SWEPT

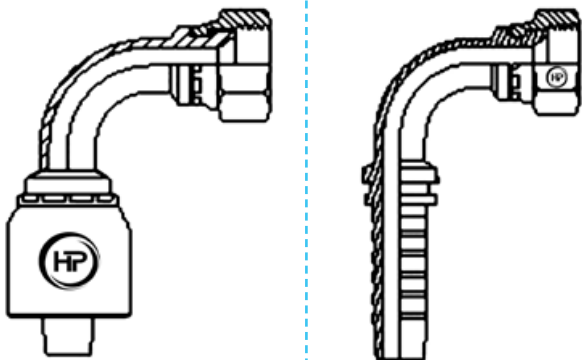

Page 15

JIC FEMALE SWIVEL
90° LONG DROP

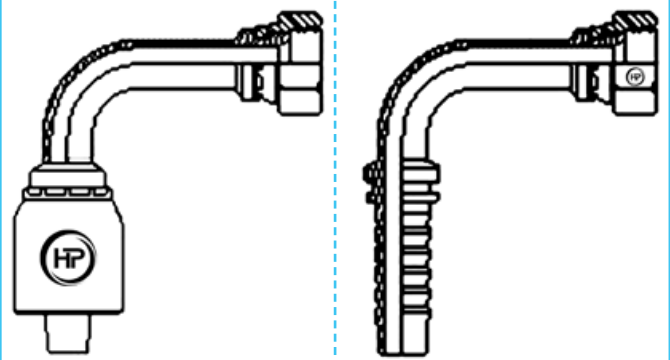

Page 15

JIC FEMALE SWIVEL
45° SWEPT

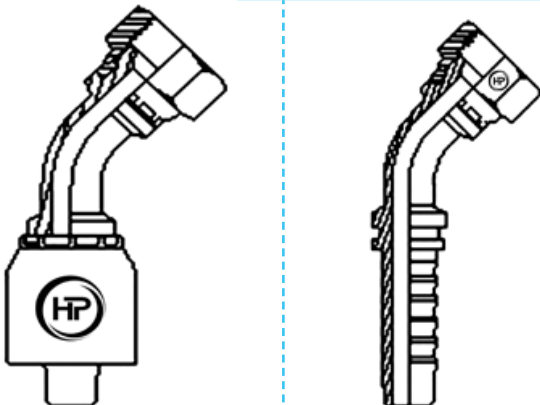

Page 16

JIC MALE
STRAIGHT

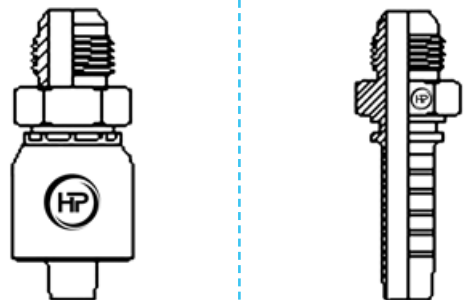

Page 16

For other sizes and thread types please contact us

JIC HOSE END - STRAIGHT

JIC Female Swivel Straight, Suitable for 1 & 2 Wire

*Two piece price includes Ferrule



Part Number		Hose	JIC	List price (\$)	
One Piece	Two Piece	(A)	(B)	One Piece	Two Piece
HE1-04/JFS07	HE2-04/JFS07	1/4"	7/16"	9.85	POA
HE1-04/JFS08	HE2-04/JFS08	1/4"	1/2"	15.00	POA
HE1-04/JFS09	HE2-04/JFS09	1/4"	9/16"	10.31	POA
HE1-05/JFS09	HE2-05/JFS09	5/16"	9/16"	POA	14.95
HE1-06/JFS09	HE2-06/JFS09	3/8"	9/16"	11.77	11.28
HE1-08/JFS09	HE2-08/JFS09	1/2"	9/16"	POA	14.45
HE1-04/JFS12	HE2-04/JFS12	1/4"	3/4"	15.37	POA
HE1-06/JFS12	HE2-06/JFS12	3/8"	3/4"	12.51	11.95
HE1-08/JFS12	HE2-08/JFS12	1/2"	3/4"	15.23	13.18
HE1-10/JFS12	HE2-10/JFS12	5/8"	3/4"	POA	21.53
HE1-06/JFS14	HE2-06/JFS14	3/8"	7/8"	19.71	16.70
HE1-08/JFS14	HE2-08/JFS14	1/2"	7/8"	16.09	14.48
HE1-10/JFS14	HE2-10/JFS14	5/8"	7/8"	22.88	23.93
HE1-12/JFS14	HE2-12/JFS14	3/4"	7/8"	POA	23.40
HE1-08/JFS17	HE2-08/JFS17	1/2"	1.1/16"	26.17	22.23
HE1-10/JFS17	HE2-10/JFS17	5/8"	1.1/16"	26.37	25.93
HE1-12/JFS17	HE2-12/JFS17	3/4"	1.1/16"	24.11	24.10
HE1-16/JFS17	HE2-16/JFS17	1"	1.1/16"	40.00	42.30
HE1-12/JFS19	HE2-12/JFS19	3/4"	1.3/16"	POA	35.50
HE1-12/JFS21	HE2-12/JFS21	3/4"	1.5/16"	45.37	52.80
HE1-16/JFS21	HE2-16/JFS21	1"	1.5/16"	39.60	36.74
HE1-16/JFS26	HE2-16/JFS26	1"	1.5/8"	POA	54.20
HE1-20/JFS26	HE2-20/JFS26	1.1/4"	1.5/8"	POA	68.23
HE1-20/JFS30	HE2-20/JFS30	1.1/4"	1.7/8"	POA	85.23
HE1-24/JFS30	HE2-24/JFS30	1.1/2"	1.7/8"	POA	91.76
HE1-32/JFS40	HE2-32/JFS40	2"	2.1/2"	POA	194.96

JIC HOSE END - 90° COMPACT

JIC Female Swivel 90° Compact Elbow, Suitable for 1 & 2 Wire

*Two piece price includes Ferrule

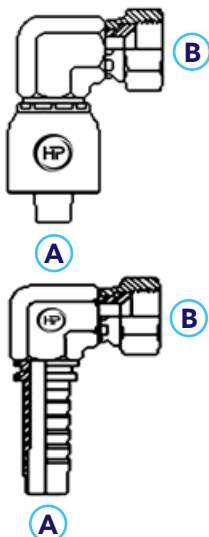

Part Number		Hose	JIC	List price (\$)	
One Piece	Two Piece	(A)	(B)	One Piece	Two Piece
HE1-04/JFS07-9C	HE2-04/JFS07-9C	1/4"	7/16"	28.88	POA
HE1-04/JFS08-9C	HE2-04/JFS08-9C	1/4"	1/2"	POA	POA
HE1-04/JFS09-9C	HE2-04/JFS09-9C	1/4"	9/16"	28.05	POA
HE1-06/JFS09-9C	HE2-06/JFS09-9C	3/8"	9/16"	26.98	25.18
HE1-06/JFS12-9C	HE2-06/JFS12-9C	3/8"	3/4"	28.33	27.25
HE1-08/JFS12-9C	HE2-08/JFS12-9C	1/2"	3/4"	35.23	31.38
HE1-08/JFS14-9C	HE2-08/JFS14-9C	1/2"	7/8"	35.88	34.51
HE1-08/JFS17-9C	HE2-08/JFS17-9C	1/2"	1.1/16"	POA	42.28
HE1-12/JFS17-9C	HE2-12/JFS17-9C	3/4"	1.1/16"	50.53	49.20
HE1-16/JFS21-9C	HE2-16/JFS21-9C	1"	1.5/16"	74.02	79.99

HOSE END - 90° SWEPT

JIC Female Swivel 90° Swept Elbow, Suitable for 1 & 2 Wire

*Two piece price includes Ferrule

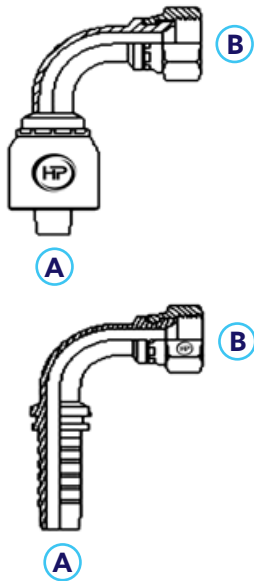

Part Number		Hose	JIC	List price (\$)	
One Piece	Two Piece	(A)	(B)	One Piece	Two Piece
HE1-04/JFS07-9S	HE2-04/JFS07-9S	1/4"	7/16"	22.15	POA
HE1-04/JFS08-9S	HE2-04/JFS08-9S	1/4"	1/2"	34.95	POA
HE1-04/JFS09-9S	HE2-04/JFS09-9S	1/4"	9/16"	23.45	POA
HE1-06/JFS09-9S	HE2-06/JFS09-9S	3/8"	9/16"	24.84	25.08
HE1-04/JFS12-9S	HE2-04/JFS12-9S	1/4"	3/4"	31.50	POA
HE1-06/JFS12-9S	HE2-06/JFS12-9S	3/8"	3/4"	25.94	26.18
HE1-08/JFS12-9S	HE2-08/JFS12-9S	1/2"	3/4"	28.28	29.03
HE1-06/JFS14-9S	HE2-06/JFS14-9S	3/8"	7/8"	45.20	34.05
HE1-08/JFS14-9S	HE2-08/JFS14-9S	1/2"	7/8"	29.65	37.18
HE1-10/JFS14-9S	HE2-10/JFS14-9S	5/8"	7/8"	37.27	39.36
HE1-12/JFS14-9S	HE2-12/JFS14-9S	3/4"	7/8"	63.95	63.60
HE1-08/JFS17-9S	HE2-08/JFS17-9S	1/2"	1.1/16"	59.80	47.98
HE1-10/JFS17-9S	HE2-10/JFS17-9S	5/8"	1.1/16"	47.58	45.71
HE1-12/JFS17-9S	HE2-12/JFS17-9S	3/4"	1.1/16"	41.44	43.62
HE1-12/JFS19-9S	HE2-12/JFS19-9S	3/4"	1.3/16"	POA	82.75
HE1-12/JFS21-9S	HE2-12/JFS21-9S	3/4"	1.5/16"	POA	73.97
HE1-16/JFS21-9S	HE2-16/JFS21-9S	1"	1.5/16"	81.35	67.52
HE1-16/JFS26-9S	HE2-16/JFS26-9S	1"	1.5/8"	POA	89.34
HE1-20/JFS26-9S	HE2-20/JFS26-9S	1.1/4"	1.5/8"	POA	134.03
HE1-24/JFS30-9S	HE2-24/JFS30-9S	1.1/2"	1.7/8"	POA	198.19
HE1-32/JFS40-9S	HE2-32/JFS40-9S	2"	2.1/2"	POA	478.36

HOSE END - 90° LONG DROP

JIC Female Swivel 90° Long Drop Elbow, Suitable for 1 & 2 Wire

*Two piece price includes Ferrule

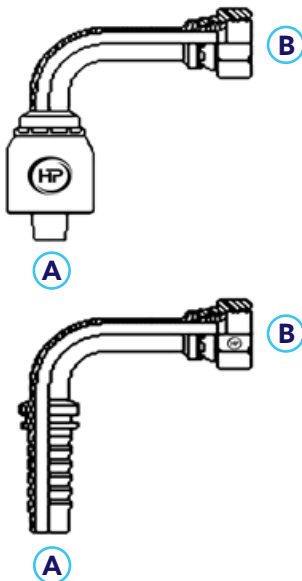

Part Number		Hose	JIC	List price (\$)	
One Piece	Two Piece	(A)	(B)	One Piece	Two Piece
HE1-04/JFS07-9L	HE2-04/JFS07-9L	1/4"	7/16"	POA	POA
HE1-04/JFS09-9L	HE2-04/JFS09-9L	1/4"	9/16"	40.50	POA
HE1-06/JFS09-9L	HE2-06/JFS09-9L	3/8"	9/16"	40.13	35.68
HE1-06/JFS12-9L	HE2-06/JFS12-9L	3/8"	3/4"	41.78	36.78
HE1-08/JFS12-9L	HE2-08/JFS12-9L	1/2"	3/4"	45.93	38.14
HE1-08/JFS14-9L	HE2-08/JFS14-9L	1/2"	7/8"	POA	41.76
HE1-10/JFS14-9L	HE2-10/JFS14-9L	5/8"	7/8"	POA	51.58
HE1-12/JFS17-9L	HE2-12/JFS17-9L	3/4"	1.1/16"	66.92	61.79
HE1-16/JFS21-9L	HE2-16/JFS21-9L	1"	1.5/16"	99.13	88.39

HOSE END - 45° ELBOW

JIC Female Swivel 45° Swept Elbow, Suitable for 1 & 2 Wire

*Two piece price includes Ferrule

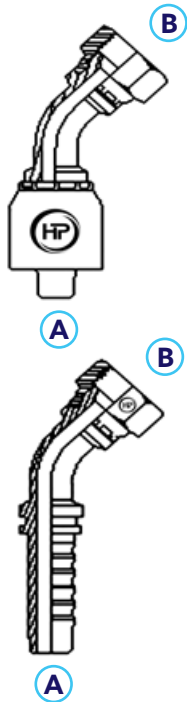

Part Number		Hose	JIC	List price (\$)	
One Piece	Two Piece	(A)	(B)	One Piece	Two Piece
HE1-04/JFS07-4S	HE2-04/JFS07-4S	1/4"	7/16"	22.94	POA
HE1-04/JFS08-4S	HE2-04/JFS08-4S	1/4"	1/2"	36.18	POA
HE1-04/JFS09-4S	HE2-04/JFS09-4S	1/4"	9/16"	25.04	POA
HE1-06/JFS09-4S	HE2-06/JFS09-4S	3/8"	9/16"	27.11	30.20
HE1-06/JFS12-4S	HE2-06/JFS12-4S	3/8"	3/4"	27.64	28.73
HE1-08/JFS12-4S	HE2-08/JFS12-4S	1/2"	3/4"	29.16	29.88
HE1-08/JFS14-4S	HE2-08/JFS14-4S	1/2"	7/8"	31.63	33.28
HE1-10/JFS14-4S	HE2-10/JFS14-4S	5/8"	7/8"	35.02	39.68
HE1-08/JFS17-4S	HE2-08/JFS17-4S	1/2"	1.1/16"	POA	51.43
HE1-10/JFS17-4S	HE2-10/JFS17-4S	1/2"	1.1/16"	44.35	45.08
HE1-12/JFS17-4S	HE2-12/JFS17-4S	3/4"	1.1/16"	42.75	46.65
HE1-12/JFS19-4S	HE2-12/JFS19-4S	3/4"	1.3/16"	POA	77.80
HE1-12/JFS21-4S	HE2-12/JFS21-4S	3/4"	1.5/16"	POA	78.55
HE1-16/JFS21-4S	HE2-16/JFS21-4S	1"	1.5/16"	65.30	70.34
HE1-20/JFS26-4S	HE2-20/JFS26-4S	1.1/4"	1.5/8"	POA	132.68
HE1-24/JFS30-4S	HE2-24/JFS30-4S	1.1/2"	1.7/8"	POA	213.46
HE1-32/JFS40-4S	HE2-32/JFS40-4S	2"	2.1/2"	POA	628.16

HOSE END - STRAIGHT

JIC Male Straight, Suitable for 1 & 2 Wire

*Two piece price includes Ferrule



Part Number		Hose	JIC	List price (\$)	
One Piece	Two Piece	(A)	(B)	One Piece	Two Piece
HE1-04/JM07	HE2-04/JM07	1/4"	7/16"	13.85	POA
HE1-04/JM08	HE2-04/JM08	1/4"	1/2"	19.60	POA
HE1-04/JM09	HE2-04/JM09	1/4"	9/16"	12.50	POA
HE1-06/JM09	HE2-06/JM09	3/8"	9/16"	14.25	13.68
HE1-04/JM12	HE2-04/JM12	1/4"	3/4"	POA	POA
HE1-06/JM12	HE2-06/JM12	3/8"	3/4"	16.35	16.13
HE1-08/JM12	HE2-08/JM12	1/2"	3/4"	17.61	16.73
HE1-06/JM14	HE2-06/JM14	3/8"	7/8"	20.50	17.38
HE1-08/JM14	HE2-08/JM14	1/2"	7/8"	19.63	17.61
HE1-10/JM14	HE2-10/JM14	5/8"	7/8"	22.85	24.81
HE1-12/JM14	HE2-12/JM14	3/4"	7/8"	POA	32.82
HE1-08/JM17	HE2-08/JM17	1/2"	1.1/16"	POA	26.06
HE1-10/JM17	HE2-10/JM17	5/8"	1.1/16"	25.16	30.28
HE1-12/JM17	HE2-12/JM17	3/4"	1.1/16"	27.50	27.27
HE1-12/JM21	HE2-12/JM21	3/4"	1.5/16"	48.80	39.70
HE1-16/JM21	HE2-16/JM21	1"	1.5/16"	44.06	44.02
HE1-16/JM26	HE2-16/JM26	1"	1.5/8"	POA	71.09
HE1-20/JM26	HE2-20/JM26	1.1/4"	1.5/8"	POA	88.08
HE1-24/JM30	HE2-24/JM30	1.1/2"	1.7/8"	POA	170.61
HE1-32/JM40	HE2-32/JM40	2"	2.1/2"	POA	345.46

BSP FEMALE SWIVEL STRAIGHT

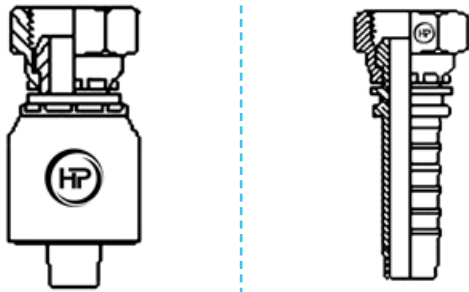

Page 18

BSP MALE STRAIGHT

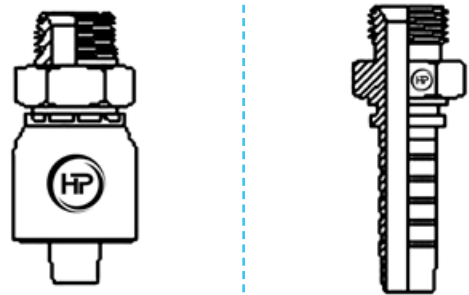

Page 18

BSPT MALE STRAIGHT

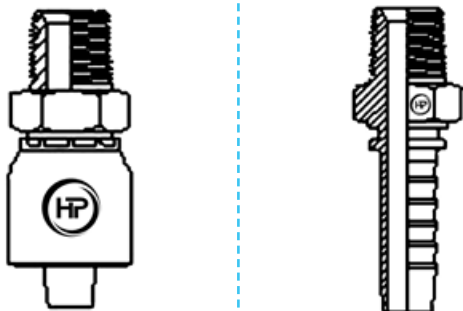

Page 19

BSP FEMALE SWIVEL 90° COMPACT

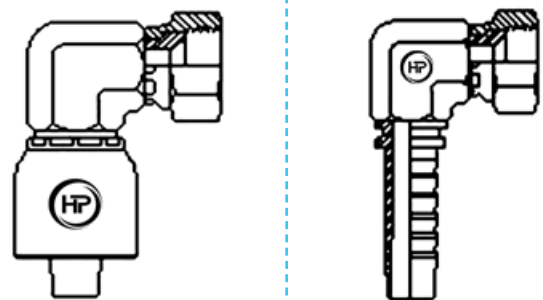

Page 19

BSP FEMALE SWIVEL 90° SWEPT

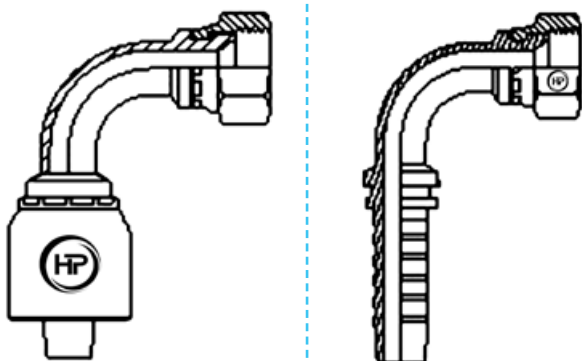

Page 20

BSP FEMALE SWIVEL 45° SWEPT

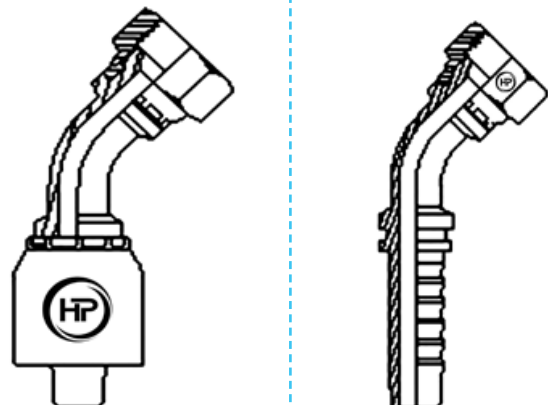

Page 20

For other sizes and thread types please contact us

HOSE END - STRAIGHT

BSPF Female Swivel Straight, Suitable for 1 & 2 Wire

*Two piece price includes Ferrule

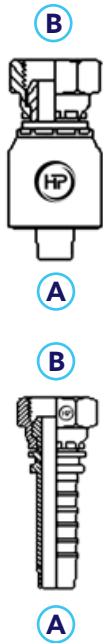

Part Number		Hose	BSPF	List price (\$)	
One Piece	Two Piece	A	B	One Piece	Two Piece
HE1-04/PFS02	HE2-04/PFS02	1/4"	1/8"	14.08	POA
HE1-04/PFS04	HE2-04/PFS04	1/4"	1/4"	11.21	POA
HE1-06/PFS04	HE2-06/PFS04	3/8"	1/4"	POA	14.38
HE1-04/PFS06	HE2-04/PFS06	1/4"	3/8"	14.83	POA
HE1-06/PFS06	HE2-06/PFS06	3/8"	3/8"	12.00	10.95
HE1-08/PFS06	HE2-08/PFS06	1/2"	3/8"	21.43	16.73
HE1-06/PFS08	HE2-06/PFS08	3/8"	1/2"	17.43	13.55
HE1-08/PFS08	HE2-08/PFS08	1/2"	1/2"	17.32	14.03
HE1-10/PFS08	HE2-10/PFS08	5/8"	1/2"	30.70	23.33
HE1-08/PFS10	HE2-08/PFS10	1/2"	5/8"	POA	22.63
HE1-10/PFS10	HE2-10/PFS10	5/8"	5/8"	POA	29.53
HE1-08/PFS12	HE2-08/PFS12	1/2"	3/4"	27.14	33.78
HE1-10/PFS12	HE2-10/PFS12	5/8"	3/4"	POA	37.78
HE1-12/PFS12	HE2-12/PFS12	3/4"	3/4"	23.49	23.80
HE1-12/PFS16	HE2-12/PFS16	3/4"	1"	51.20	51.25
HE1-16/PFS16	HE2-16/PFS16	1"	1"	42.50	40.67
HE1-16/PFS20	HE2-16/PFS20	1"	1.1/4"	POA	60.84
HE1-20/PFS20	HE2-20/PFS20	1.1/4"	1.1/4"	POA	92.88
HE1-20/PFS24	HE2-20/PFS24	1.1/4"	1.1/2"	POA	142.13
HE1-24/PFS24	HE2-24/PFS24	1.1/2"	1.1/2"	POA	129.31
HE1-32/PFS32	HE2-32/PFS32	2"	2"	POA	243.81

HOSE END - STRAIGHT

BSPF Male Straight, Suitable for 1 & 2 Wire

*Two piece price includes Ferrule

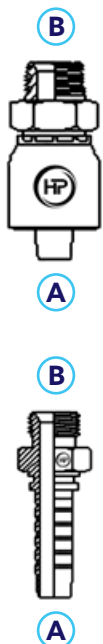

Part Number		Hose	BSPF	List price (\$)	
One Piece	Two Piece	A	B	One Piece	Two Piece
HE1-04/PM02	HE2-04/PM02	1/4"	1/8"	POA	POA
HE1-04/PM04	HE2-04/PM04	1/4"	1/4"	POA	POA
HE1-04/PM06	HE2-04/PM06	1/4"	3/8"	POA	POA
HE1-06/PM06	HE2-06/PM06	3/8"	3/8"	14.70	15.40
HE1-08/PM06	HE2-08/PM06	1/2"	3/8"	POA	19.13
HE1-06/PM08	HE2-06/PM08	3/8"	1/2"	20.75	16.35
HE1-08/PM08	HE2-08/PM08	1/2"	1/2"	17.90	16.36
HE1-08/PM12	HE2-08/PM12	1/2"	3/4"	POA	30.78
HE1-10/PM12	HE2-10/PM12	5/8"	3/4"	POA	36.13
HE1-12/PM12	HE2-12/PM12	3/4"	3/4"	POA	28.65
HE1-12/PM16	HE2-12/PM16	3/4"	1"	POA	49.25
HE1-16/PM16	HE2-16/PM16	1"	1"	POA	51.52
HE1-20/PM20	HE2-20/PM20	1.1/4"	1.1/4"	POA	112.51
HE1-24/PM24	HE2-24/PM24	1.1/2"	1.1/2"	POA	112.61
HE1-32/PM32	HE2-32/PM32	2"	2"	POA	197.26

HOSE END - STRAIGHT

BSPT Male Straight, Suitable for 1 & 2 Wire

*Two piece price includes Ferrule



A

B



A

Part Number		Hose	BSPT	List price (\$)	
One Piece	Two Piece	A	B	One Piece	Two Piece
HE1-04/TM02	HE2-04/TM02	1/4"	1/8"	12.77	POA
HE1-04/TM04	HE2-04/TM04	1/4"	1/4"	11.45	POA
HE1-06/TM04	HE2-06/TM04	3/8"	1/4"	15.21	16.73
HE1-04/TM06	HE2-04/TM06	1/4"	3/8"	15.15	POA
HE1-06/TM06	HE2-06/TM06	3/8"	3/8"	13.05	11.63
HE1-08/TM06	HE2-08/TM06	1/2"	3/8"	14.18	19.21
HE1-04/TM08	HE2-04/TM08	1/4"	1/2"	11.50	POA
HE1-06/TM08	HE2-06/TM08	3/8"	1/2"	15.98	13.15
HE1-08/TM08	HE2-08/TM08	1/2"	1/2"	15.31	13.13
HE1-10/TM08	HE2-10/TM08	5/8"	1/2"	22.35	28.88
HE1-12/TM08	HE2-12/TM08	3/4"	1/2"	38.30	36.62
HE1-08/TM10	HE2-08/TM10	1/2"	5/8"	POA	25.48
HE1-10/TM10	HE2-10/TM10	5/8"	5/8"	POA	39.71
HE1-06/TM12	HE2-06/TM12	3/8"	3/4"	POA	28.28
HE1-08/TM12	HE2-08/TM12	1/2"	3/4"	POA	36.71
HE1-10/TM12	HE2-10/TM12	5/8"	3/4"	POA	49.63
HE1-12/TM12	HE2-12/TM12	3/4"	3/4"	22.14	23.82
HE1-12/TM16	HE2-12/TM16	3/4"	1"	47.15	70.45
HE1-16/TM16	HE2-16/TM16	1"	1"	41.55	52.94
HE1-16/TM20	HE2-16/TM20	1"	1.1/4"	POA	221.09
HE1-20/TM20	HE2-20/TM20	1.1/4"	1.1/4"	POA	82.58
HE1-24/TM24	HE2-24/TM24	1.1/2"	1.1/2"	POA	104.79
HE1-32/TM32	HE2-32/TM32	2"	2"	POA	193.18

HOSE END - 90° COMPACT

BSPF Female Swivel 90° Compact Elbow, Suitable for 1 & 2 Wire

*Two piece price includes Ferrule

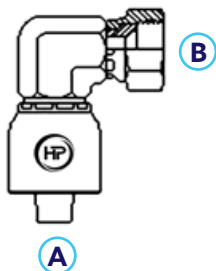

A

B

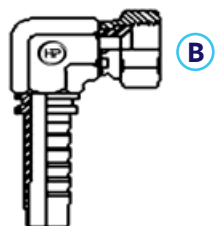

A

B

Part Number		Hose	BSPF	List price (\$)	
One Piece	Two Piece	A	B	One Piece	Two Piece
HE1-04/PFS04-9C	HE2-04/PFS04-9C	1/4"	1/4"	25.38	POA
HE1-04/PFS06-9C	HE2-04/PFS06-9C	1/4"	3/8"	POA	POA
HE1-06/PFS06-9C	HE2-06/PFS06-9C	3/8"	3/8"	27.53	27.28
HE1-06/PFS08-9C	HE2-06/PFS08-9C	3/8"	1/2"	POA	19.73
HE1-08/PFS08-9C	HE2-08/PFS08-9C	1/2"	1/2"	33.93	30.76
HE1-12/PFS12-9C	HE2-12/PFS12-9C	3/4"	3/4"	49.49	51.15
HE1-16/PFS16-9C	HE2-16/PFS16-9C	1"	1"	100.85	82.04

HOSE END - 90° SWEPT

BSPF Female Swivel 90° Swept Elbow, Suitable for 1 & 2 Wire

*Two piece price includes Ferrule

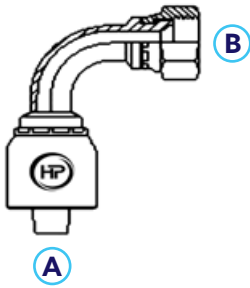

A

A

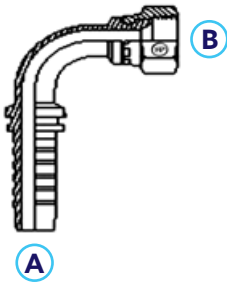

Part Number		Hose	BSPF	List price (\$)	
One Piece	Two Piece	A	B	One Piece	Two Piece
HE1-04/PFS04-9S	HE2-04/PFS04-9S	1/4"	1/4"	23.29	POA
HE1-04/PFS06-9S	HE2-04/PFS06-9S	1/4"	3/8"	40.90	POA
HE1-06/PFS06-9S	HE2-06/PFS06-9S	3/8"	3/8"	25.74	26.75
HE1-06/PFS08-9S	HE2-06/PFS08-9S	3/8"	1/2"	37.80	36.43
HE1-08/PFS08-9S	HE2-08/PFS08-9S	1/2"	1/2"	29.06	29.56
HE1-08/PFS10-9S	HE2-08/PFS10-9S	1/2"	5/8"	POA	39.08
HE1-10/PFS10-9S	HE2-10/PFS10-9S	5/8"	5/8"	POA	48.93
HE1-08/PFS12-9S	HE2-08/PFS12-9S	1/2"	3/4"	POA	48.38
HE1-10/PFS12-9S	HE2-10/PFS12-9S	5/8"	3/4"	POA	55.83
HE1-12/PFS12-9S	HE2-12/PFS12-9S	3/4"	3/4"	41.69	44.35
HE1-16/PFS16-9S	HE2-16/PFS16-9S	1"	1"	66.93	71.99
HE1-20/PFS20-9S	HE2-20/PFS20-9S	1.1/4"	1.1/4"	POA	136.73
HE1-24/PFS24-9S	HE2-24/PFS24-9S	1.1/2"	1.1/2"	POA	214.69
HE1-32/PFS32-9S	HE2-32/PFS32-9S	2"	2"	POA	363.53

HOSE END - 45° SWEPT

BSPF Female Swivel 45° Swept Elbow, Suitable for 1 & 2 Wire

*Two piece price includes Ferrule

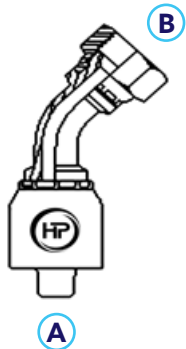

A

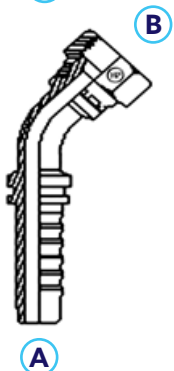

A

Part Number		Hose	BSPF	List price (\$)	
One Piece	Two Piece	A	B	One Piece	Two Piece
HE1-04/PFS04-4S	HE2-04/PFS04-4S	1/4"	1/4"	24.74	POA
HE1-04/PFS06-4S	HE2-04/PFS06-4S	1/4"	3/8"	33.60	POA
HE1-06/PFS06-4S	HE2-06/PFS06-4S	3/8"	3/8"	27.14	28.95
HE1-06/PFS08-4S	HE2-06/PFS08-4S	3/8"	1/2"	POA	39.63
HE1-08/PFS08-4S	HE2-08/PFS08-4S	1/2"	1/2"	30.10	31.38
HE1-10/PFS10-4S	HE2-10/PFS10-4S	5/8"	5/8"	POA	62.73
HE1-12/PFS12-4S	HE2-12/PFS12-4S	3/4"	3/4"	42.94	46.42
HE1-16/PFS16-4S	HE2-16/PFS16-4S	1"	1"	67.20	71.39
HE1-20/PFS20-4S	HE2-20/PFS20-4S	1.1/4"	1.1/4"	POA	157.33
HE1-24/PFS24-4S	HE2-24/PFS24-4S	1.1/2"	1.1/2"	POA	268.11
HE1-32/PFS32-4S	HE2-32/PFS32-4S	2"	2"	POA	523.36

ADAPTORS

CODING SYSTEM



Adaptors

①		②		③		④		⑤		⑥		⑦		⑧					
SERIES		THREAD TYPE		THREAD CONFIG		THREAD SIZE		THREAD TYPE		THREAD CONFIG		THREAD SIZE		THREAD ORIENT					
A	STRAIGHT	J	JIC	M	MALE	JIC, UNO	BSPP, BSPT	J	JIC	M	MALE	JIC, UNO	BSPP, BSPT	9	90° ELBOW				
	90 DEGREE	U	UNO	MS	MALE SWIVEL	05	5/16"	02	1/8"	U	UNO	MS	MALE SWIVEL	05	5/16"	02	1/8"	9B	90° BEND
	45 DEGREE	P	BSPP	F	FEMALE	07	7/16"	04	1/4"	P	BSPP	F	FEMALE	07	7/16"	04	1/4"	9L	90° LONG BEND
	TEE	T	BSPT	FS	FEMALE SWIVEL	08	1/2"	06	3/8"	T	BSPT	FS	FEMALE SWIVEL	08	1/2"	06	3/8"	4	45° ELBOW
	REDUCER	M	METRIC	FL	FLANGE	09	9/16"	08	1/2"	M	METRIC	FS	FEMALE SWIVEL	09	9/16"	08	1/2"	4B	45° BEND
	SOCKET	N	NPT			12	3/4"	10	5/8"	N	NPT	FL	FLANGE	12	3/4"	10	5/8"	E	EXTENDED
	BUSH	O	ORFS			14	7/8"	12	3/4"	O	ORFS			14	7/8"	12	3/4"		
		S	SAE			17	1.1/16"	16	1"	S	SAE			17	1.1/16"	16	1"		
						19	1.3/16"	20	1.1/4"					19	1.3/16"	20	1.1/4"		
						21	1.5/16"	24	1.1/2"					21	1.5/16"	24	1.1/2"		
BH	BULKHEAD																		
BB	BANJO BOLT																		
C	CAP																		
P	PLUG																		
PH	PLUG HEX																		
						ORFS		METRIC				ORFS		METRIC					
						09	9/16"	12	M12 x 1.5			09	9/16"	12	M12 x 1.5				
						11	11/16"	14	M14 x 1.5			11	11/16"	14	M14 x 1.5				
						13	13/16"	16	M16 x 1.5			13	13/16"	16	M16 x 1.5				
						16	1"	18	M18 x 1.5			16	1"	18	M18 x 1.5				
						19	1.3/16"	20	M20 x 1.5			19	1.3/16"	20	M20 x 1.5				
						23	1.7/16"	22	M22 x 1.5			23	1.7/16"	22	M22 x 1.5				
						27	1.11/16"	24	M24 x 1.5			27	1.11/16"	24	M24 x 1.5				
						32	2"	26	M26 x 1.5			32	2"	26	M26 x 1.5				
								30	M30 x 2.0					30	M30 x 2.0				
								36	M36 x 2.0					36	M36 x 2.0				
								42	M42 x 2.0					42	M42 x 2.0				
								45	M45 x 2.0					45	M45 x 2.0				
								52	M52 x 2.0					52	M52 x 2.0				

Example (Adaptor)
A-JM09/JFS09-9
 JIC Male 9/16", JIC Female Swivel 9/16"
 90° Elbow

Example (Tee)
A-JM09/TM04/JM09
 JIC Male 9/16", BSPT 1/4", JIC Male 9/16"
 Run Tee

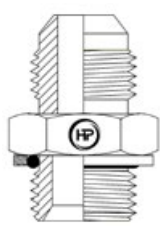
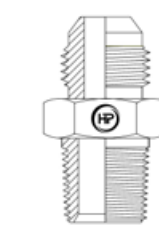
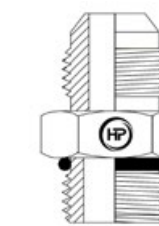
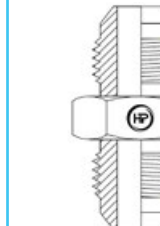
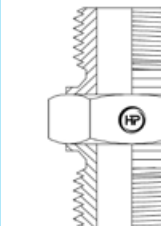
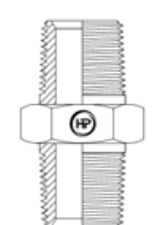
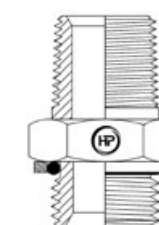
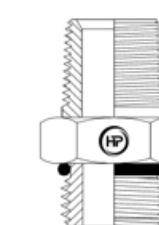
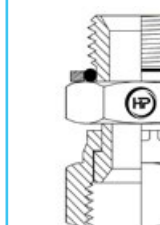
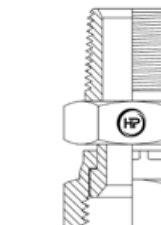
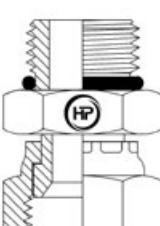
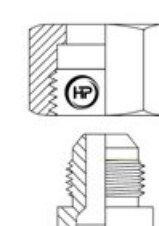
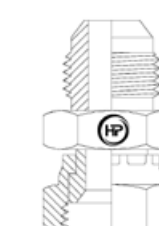
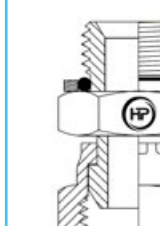
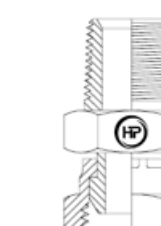
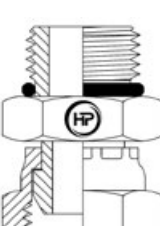
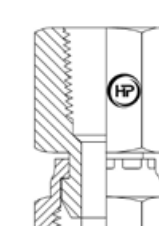
For **TEES** use 1-7 above, then add 5-7 again to complete TEE code

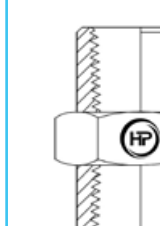
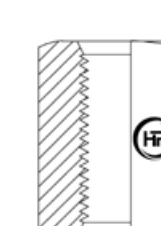
<p>JICM X BSPPM STRAIGHT (M X M)</p>  <p>Page 24</p>	<p>JICM X BSPTM STRAIGHT (M X M)</p>  <p>Page 25</p>	<p>JICM X UNOM STRAIGHT (M X M)</p>  <p>Page 26</p>	<p>JICM X JICM STRAIGHT (M X M)</p>  <p>Page 27</p>	<p>BSPPM X BSPPM STRAIGHT (M X M)</p>  <p>Page 27</p>
<p>BSPTM X BSPTM STRAIGHT (M X M)</p>  <p>Page 28</p>	<p>BSPTM X BSPPM STRAIGHT (M X M)</p>  <p>Page 28</p>	<p>BSPTM X UNOM STRAIGHT (M X M)</p>  <p>Page 29</p>	<p>BSPPM X JICF STRAIGHT (M X FS)</p>  <p>Page 30</p>	<p>BSPTM X JICF STRAIGHT (M X FS)</p>  <p>Page 30</p>
<p>UNOM X JICF STRAIGHT (M X FS)</p>  <p>Page 31</p>	<p>JICM X JICF (TR) STRAIGHT (M X FS)</p>  <p>Page 31</p>	<p>JICM X JICF STRAIGHT (M X FS)</p>  <p>Page 31</p>	<p>BSPPM X BSPPF STRAIGHT (M X FS)</p>  <p>Page 32</p>	<p>BSPTM X BSPPF STRAIGHT (M X FS)</p>  <p>Page 32</p>
<p>UNOM X BSPPF STRAIGHT (M X FS)</p>  <p>Page 33</p>	<p>BSPTF X BSPPF STRAIGHT (F X FS)</p>  <p>Page 33</p>	<p>BSPPF X BSPPF STRAIGHT FIXED (F X F)</p>  <p>Page 34</p>	<p>BSPTF X BSPTF STRAIGHT FIXED (F X F)</p>  <p>Page 34</p>	<p>UNOF X UNOF STRAIGHT FIXED (F X F)</p>  <p>Page 34</p>

For other sizes and thread types please contact us

ADAPTOR - STRAIGHT (M X M)

JIC Male x BSPP Male - Straight

Part Number	A JIC (M)	B BSPP (M)	List Price (\$)
A-JM07/PM02	7/16"	1/8"	8.50
A-JM07/PM04	7/16"	1/4"	6.02
A-JM07/PM06	7/16"	3/8"	8.95
A-JM07/PM08	7/16"	1/2"	13.35
A-JM08/PM04	1/2"	1/4"	9.43
A-JM09/PM02	9/16"	1/8"	9.88
A-JM09/PM04	9/16"	1/4"	7.40
A-JM09/PM06	9/16"	3/8"	6.47
A-JM09/PM08	9/16"	1/2"	9.08
A-JM09/PM12	9/16"	3/4"	17.10
A-JM12/PM04	3/4"	1/4"	8.97
A-JM12/PM06	3/4"	3/8"	6.88
A-JM12/PM06-E70	3/4"	3/8"	15.96
A-JM12/PM06-E95	3/4"	3/8"	20.93
A-JM12/PM08	3/4"	1/2"	7.70
A-JM12/PM12	3/4"	3/4"	13.03
A-JM12/PM16	3/4"	1"	22.80
A-JM14/PM06	7/8"	3/8"	11.25
A-JM14/PM08	7/8"	1/2"	8.09
A-JM14/PM12	7/8"	3/4"	13.93
A-JM14/PM16	7/8"	1"	29.22
A-JM17/PM04	1.1/16"	1/4"	29.12
A-JM17/PM06	1.1/16"	3/8"	18.20
A-JM17/PM08	1.1/16"	1/2"	12.65
A-JM17/PM12	1.1/16"	3/4"	13.18
A-JM17/PM16	1.1/16"	1"	21.65
A-JM17/PM20	1.1/16"	1.1/4"	41.23
A-JM17/PM24	1.1/16"	1.1/2"	142.60
A-JM21/PM12	1.5/16"	3/4"	25.45
A-JM21/PM16	1.5/16"	1"	20.80
A-JM21/PM20	1.5/16"	1.1/4"	38.97
A-JM21/PM24	1.5/16"	1.1/2"	78.60
A-JM21/PM32	1.5/16"	2"	168.49
A-JM26/PM12	1.5/8"	3/4"	107.53
A-JM26/PM16	1.5/8"	1"	29.80
A-JM26/PM20	1.5/8"	1.1/4"	39.56
A-JM26/PM24	1.5/8"	1.1/2"	89.80
A-JM30/PM16	1.7/8"	1"	99.50
A-JM30/PM20	1.7/8"	1.1/4"	87.60
A-JM30/PM24	1.7/8"	1.1/2"	74.30
A-JM30/PM32	1.7/8"	2"	125.58
A-JM40/PM32	2.1/2"	2"	128.78

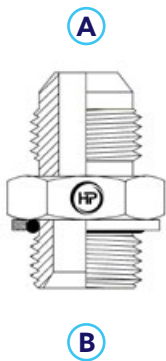

ADAPTOR - STRAIGHT (M X M)

JIC Male x BSPT Male - Straight

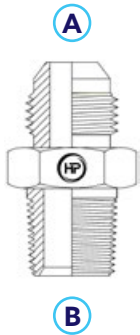

Part Number	A JIC (M)	B BSPT (M)	List Price (\$)
A-JM07/TM02	7/16"	1/8"	3.14
A-JM07/TM04	7/16"	1/4"	3.45
A-JM07/TM06	7/16"	3/8"	6.73
A-JM07/TM08	7/16"	1/2"	10.70
A-JM08/TM02	1/2"	1/8"	5.87
A-JM08/TM04	1/2"	1/4"	4.12
A-JM08/TM06	1/2"	3/8"	10.45
A-JM09/TM02	9/16"	1/8"	4.05
A-JM09/TM04	9/16"	1/4"	3.38
A-JM09/TM06	9/16"	3/8"	3.98
A-JM09/TM08	9/16"	1/2"	6.40
A-JM09/TM12	9/16"	3/4"	11.78
A-JM12/TM04	3/4"	1/4"	7.33
A-JM12/TM06	3/4"	3/8"	4.24
A-JM12/TM08	3/4"	1/2"	5.36
A-JM12/TM12	3/4"	3/4"	9.21
A-JM12/TM16	3/4"	1"	19.12
A-JM14/TM06	7/8"	3/8"	6.53
A-JM14/TM08	7/8"	1/2"	5.90
A-JM14/TM12	7/8"	3/4"	7.90
A-JM14/TM16	7/8"	1.1/4"	20.32
A-JM17/TM06	1.1/16"	3/8"	12.20
A-JM17/TM08	1.1/16"	1/2"	10.30
A-JM17/TM12	1.1/16"	3/4"	7.25
A-JM17/TM16	1.1/16"	1"	13.12
A-JM17/TM20	1.1/16"	1.1/4"	33.70
A-JM21/TM08	1.5/16"	1/2"	13.35
A-JM21/TM12	1.5/16"	3/4"	13.30
A-JM21/TM16	1.5/16"	1"	12.58
A-JM21/TM20	1.5/16"	1.1/4"	25.85
A-JM21/TM24	1.5/16"	1.1/2"	52.18
A-JM26/TM16	1.5/8"	1"	29.67
A-JM26/TM20	1.5/8"	1.1/4"	27.08
A-JM26/TM24	1.5/8"	1.1/2"	51.40
A-JM26/TM32	1.5/8"	2"	85.00
A-JM30/TM20	1.7/8"	1.1/4"	52.22
A-JM30/TM24	1.7/8"	1.1/2"	44.62
A-JM30/TM32	1.7/8"	2"	100.08
A-JM40/TM24	2.1/2"	1.1/2"	68.12
A-JM40/TM32	2.1/2"	2"	98.75

ADAPTOR - STRAIGHT (M X M)

JIC Male x UNO Male - Straight

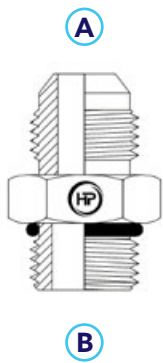

Part Number	A JIC (M)	B UNO (M)	List Price (\$)
A-JM07/UM07	7/16"	7/16"	5.35
A-JM07/UM08	7/16"	1/2"	6.15
A-JM07/UM09	7/16"	9/16"	6.75
A-JM07/UM12	7/16"	3/4"	8.95
A-JM08/UM08	1/2"	1/2"	8.27
A-JM08/UM09	1/2"	9/16"	9.43
A-JM08/UM12	1/2"	3/4"	48.70
A-JM09/UM07	9/16"	7/16"	6.65
A-JM09/UM08	9/16"	1/2"	10.45
A-JM09/UM09	9/16"	9/16"	4.38
A-JM09/UM12	9/16"	3/4"	5.29
A-JM09/UM14	9/16"	7/8"	6.72
A-JM09/UM17	9/16"	1.1/16"	15.97
A-JM12/UM07	3/4"	7/16"	15.42
A-JM12/UM09	3/4"	9/16"	5.61
A-JM12/UM12	3/4"	3/4"	4.70
A-JM12/UM14	3/4"	7/8"	6.55
A-JM12/UM17	3/4"	1.1/16"	11.10
A-JM12/UM21	3/4"	1.5/16"	29.07
A-JM14/UM09	7/8"	9/16"	14.62
A-JM14/UM12	7/8"	3/4"	8.32
A-JM14/UM14	7/8"	7/8"	6.31
A-JM14/UM17	7/8"	1.1/16"	11.12
A-JM14/UM21	7/8"	1.5/16"	19.93
A-JM17/UM12	1.1/16"	3/4"	13.05
A-JM17/UM14	1.1/16"	7/8"	11.80
A-JM17/UM17	1.1/16"	1.1/16"	9.85
A-JM17/UM19	1.1/16"	1.3/16"	27.80
A-JM17/UM21	1.1/16"	1.5/16"	15.25
A-JM17/UM26	1.1/16"	1.5/8"	41.87
A-JM21/UM14	1.5/16"	7/8"	25.05
A-JM21/UM17	1.5/16"	1.1/16"	15.85
A-JM21/UM19	1.5/16"	1.3/16"	32.35
A-JM21/UM21	1.5/16"	1.5/16"	14.05
A-JM21/UM26	1.5/16"	1.5/8"	28.55
A-JM21/UM30	1.5/16"	1.7/8"	69.57
A-JM26/UM17	1.5/8"	1.1/16"	50.60
A-JM26/UM21	1.5/8"	1.5/16"	31.20
A-JM26/UM26	1.5/8"	1.5/8"	29.27
A-JM26/UM30	1.5/8"	1.7/8"	58.88
A-JM30/UM30	1.7/8"	1.7/8"	53.28
A-JM40/UM40	2.1/2"	2.1/2"	80.50

ADAPTOR - STRAIGHT (M X M)

JIC Male x JIC Male - Straight

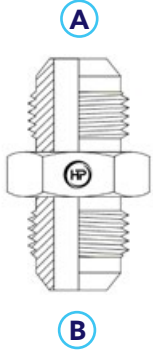

Part Number	A JIC (M)	B JIC (M)	List Price (\$)
A-JM07/JM07	7/16"	7/16"	3.32
A-JM08/JM08	1/2"	1/2"	4.31
A-JM09/JM07	9/16"	7/16"	6.47
A-JM09/JM09	9/16"	9/16"	3.45
A-JM12/JM07	3/4"	7/16"	7.23
A-JM12/JM09	3/4"	9/16"	10.22
A-JM12/JM12	3/4"	3/4"	4.95
A-JM14/JM09	7/8"	9/16"	9.95
A-JM14/JM12	7/8"	3/4"	8.07
A-JM14/JM14	7/8"	7/8"	6.60
A-JM17/JM12	1.1/16"	3/4"	16.18
A-JM17/JM14	1.1/16"	7/8"	12.88
A-JM17/JM17	1.1/16"	1.1/16"	9.90
A-JM19/JM19	1.3/16"	1.3/16"	24.18
A-JM21/JM14	1.5/16"	7/8"	16.38
A-JM21/JM17	1.5/16"	1.1/16"	16.00
A-JM21/JM21	1.5/16"	1.5/16"	13.68
A-JM26/JM21	1.5/8"	1.5/16"	33.17
A-JM26/JM26	1.5/8"	1.5/8"	30.40
A-JM30/JM30	1.7/8"	1.7/8"	85.32
A-JM40/JM40	2.1/2"	2.1/2"	159.85

ADAPTOR - STRAIGHT (M X M)

BSPM Male x BSPM Male - Straight

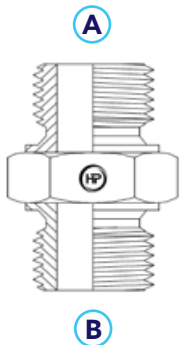

Part Number	A BSPM (M)	B BSPM (M)	List Price (\$)
A-PM04/PM04	1/4"	1/4"	6.96
A-PM06/PM04	3/8"	1/4"	7.50
A-PM06/PM06	3/8"	3/8"	7.22
A-PM08/PM04	1/2"	1/4"	9.45
A-PM08/PM06	1/2"	3/8"	7.33
A-PM08/PM08	1/2"	1/2"	8.45
A-PM12/PM08	3/4"	1/2"	11.75
A-PM12/PM12	3/4"	3/4"	11.85
A-PM16/PM08	1"	1/2"	20.55
A-PM16/PM12	1"	3/4"	19.75
A-PM16/PM16	1"	1"	19.75
A-PM20/PM20	1.1/4"	1.1/4"	40.97

ADAPTOR - STRAIGHT (M X M)

BSPT Male x BSPT Male - Straight



Part Number	A BSPT (M)	B BSPT (M)	List Price (\$)
A-TM02/TM02	1/8"	1/8"	3.88
A-TM04/TM02	1/4"	1/8"	3.23
A-TM04/TM04	1/4"	1/4"	3.15
A-TM06/TM02	3/8"	1/8"	4.05
A-TM06/TM04	3/8"	1/4"	3.42
A-TM06/TM06	3/8"	3/8"	3.44
A-TM08/TM04	1/2"	1/4"	4.80
A-TM08/TM06	1/2"	3/8"	4.50
A-TM08/TM08	1/2"	1/2"	4.93
A-TM12/TM04	3/4"	1/4"	9.70
A-TM12/TM06	3/4"	3/8"	9.90
A-TM12/TM08	3/4"	1/2"	9.50
A-TM12/TM12	3/4"	3/4"	7.58
A-TM16/TM06	1"	3/8"	15.90
A-TM16/TM08	1"	1/2"	14.50
A-TM16/TM12	1"	3/4"	10.95
A-TM16/TM16	1"	1"	11.50
A-TM20/TM12	1.1/4"	3/4"	27.35
A-TM20/TM16	1.1/4"	1"	28.85
A-TM20/TM20	1.1/4"	1.1/4"	22.88
A-TM24/TM12	1.1/2"	3/4"	65.00
A-TM24/TM16	1.1/2"	1"	43.00
A-TM24/TM20	1.1/2"	1.1/4"	37.25
A-TM24/TM24	1.1/2"	1.1/2"	60.95
A-TM32/TM20	2"	1.1/4"	70.80
A-TM32/TM24	2"	1.1/2"	65.14
A-TM32/TM32	2"	2"	55.48

ADAPTOR - STRAIGHT (M X M)

Continued...

BSPT Male x BSPP Male - Straight

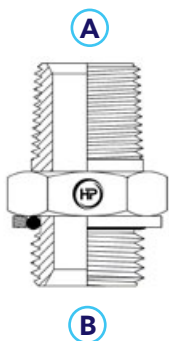

Part Number	A BSPT (M)	B BSPP (M)	List Price (\$)
A-TM02/PM02	1/8"	1/8"	6.75
A-TM02/PM04	1/8"	1/4"	7.15
A-TM04/PM02	1/4"	1/8"	7.03
A-TM04/PM04	1/4"	1/4"	5.17
A-TM04/PM06	1/4"	3/8"	7.57
A-TM04/PM08	1/4"	1/2"	10.47
A-TM06/PM04	3/8"	1/4"	6.32
A-TM06/PM06	3/8"	3/8"	6.55
A-TM06/PM08	3/8"	1/2"	8.53
A-TM06/PM12	3/8"	3/4"	13.10

Continued on the following page...

ADAPTOR - STRAIGHT (M X M)

...Continued

BSPT Male x BSPP Male - Straight

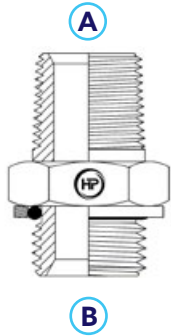

A-TM08/PM04	1/2"	1/4"	10.60
A-TM08/PM06	1/2"	3/8"	8.57
A-TM08/PM08	1/2"	1/2"	8.20
A-TM08/PM12	1/2"	3/4"	12.10
A-TM08/PM16	1/2"	1"	24.20
A-TM12/PM06	3/4"	3/8"	13.33
A-TM12/PM08	3/4"	1/2"	11.43
A-TM12/PM12	3/4"	3/4"	11.07
A-TM12/PM16	3/4"	1"	20.82
A-TM16/PM08	1"	1/2"	21.45
A-TM16/PM12	1"	3/4"	22.68
A-TM16/PM16	1"	1"	20.33
A-TM16/PM20	1"	1.1/4"	37.63
A-TM20/PM12	1.1/4"	3/4"	56.60
A-TM20/PM16	1.1/4"	1"	44.70
A-TM20/PM20	1.1/4"	1.1/4"	37.33
A-TM20/PM24	1.1/4"	1.1/2"	68.47
A-TM24/PM20	1.1/2"	1.1/4"	73.02
A-TM24/PM24	1.1/2"	1.1/2"	65.97
A-TM32/PM32	2"	2"	137.12

ADAPTOR - STRAIGHT (M X M)

BSPT Male x UNO Male - Straight

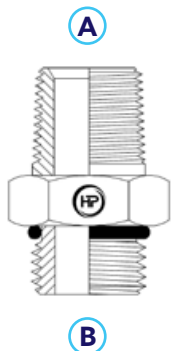

Part Number	A BSPT (M)	B UNO (M)	List Price (\$)
A-TM04/UM07	1/4"	7/16"	6.95
A-TM04/UM09	1/4"	9/16"	6.77
A-TM04/UM12	1/4"	3/4"	7.97
A-TM04/UM14	1/4"	7/8"	16.50
A-TM06/UM09	3/8"	9/16"	7.00
A-TM06/UM12	3/8"	3/4"	7.30
A-TM06/UM14	3/8"	7/8"	8.20
A-TM08/UM09	1/2"	9/16"	8.92
A-TM08/UM12	1/2"	3/4"	6.93
A-TM08/UM14	1/2"	7/8"	8.68
A-TM08/UM17	1/2"	1.1/16"	12.85
A-TM08/UM21	1/2"	1.5/16"	19.95
A-TM12/UM12	3/4"	3/4"	15.85
A-TM12/UM14	3/4"	7/8"	14.08
A-TM12/UM17	3/4"	1.1/16"	13.75
A-TM12/UM21	3/4"	1.5/16"	17.92
A-TM16/UM17	1"	1.1/16"	15.97
A-TM16/UM21	1"	1.5/16"	18.12

ADAPTOR - STRAIGHT (M X F)

BSPP Male x JIC Female Swivel - Straight

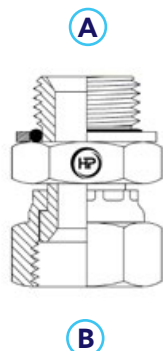

Part Number	A BSPP (M)	B JIC (FS)	List Price (\$)
A-PM02/JFS07	1/8"	7/16"	12.95
A-PM04/JFS07	1/4"	7/16"	13.12
A-PM04/JFS09	1/4"	9/16"	12.80
A-PM04/JFS12	1/4"	3/4"	15.90
A-PM06/JFS09	3/8"	9/16"	15.07
A-PM06/JFS12	3/8"	3/4"	15.45
A-PM06/JFS14	3/8"	7/8"	21.16
A-PM08/JFS09	1/2"	9/16"	17.88
A-PM08/JFS12	1/2"	3/4"	16.78
A-PM08/JFS14	1/2"	7/8"	19.72
A-PM08/JFS17	1/2"	1.1/16"	30.48
A-PM12/JFS14	3/4"	7/8"	28.13
A-PM12/JFS17	3/4"	1.1/16"	26.50
A-PM16/JFS17	1"	1.1/16"	42.04
A-PM16/JFS21	1"	1.5/16"	39.07
A-PM20/JFS26	1.1/4"	1.5/8"	65.10
A-PM24/JFS30	1.1/2"	1.7/8"	90.45

ADAPTOR - STRAIGHT (M X F)

BSPT Male x JIC Female Swivel - Straight

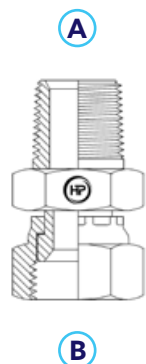

Part Number	A BSPT (M)	B JIC (FS)	List Price (\$)
A-TM02/JFS07	1/8"	7/16"	14.28
A-TM04/JFS07	1/4"	7/16"	13.62
A-TM04/JFS09	1/4"	9/16"	9.52
A-TM04/JFS14	1/4"	7/8"	17.45
A-TM06/JFS09	3/8"	9/16"	14.72
A-TM06/JFS12	3/8"	3/4"	16.27
A-TM06/JFS14	3/8"	7/8"	17.82
A-TM08/JFS09	1/2"	9/16"	16.10
A-TM08/JFS12	1/2"	3/4"	16.90
A-TM08/JFS14	1/2"	7/8"	16.52
A-TM08/JFS17	1/2"	1.1/16"	25.95
A-TM12/JFS17	3/4"	1.1/16"	24.62
A-TM16/JFS17	1"	1.1/16"	31.50
A-TM16/JFS21	1"	1.5/16"	28.88
A-TM20/JFS26	1.1/4"	1.5/8"	65.86
A-TM24/JFS26	1.1/2"	1.5/8"	150.23
A-TM24/JFS30	1.1/2"	1.7/8"	120.38

ADAPTOR - STRAIGHT (M X F)

UNO Male x JIC Female Swivel - Straight

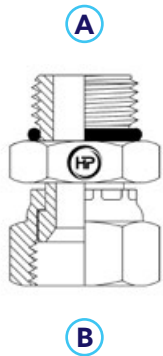

Part Number	A UNO (M)	B JIC (FS)	List Price (\$)
A-UM07/JFS07	7/16"	7/16"	8.92
A-UM07/JFS09	7/16"	9/16"	13.50
A-UM09/JFS07	9/16"	7/16"	13.55
A-UM09/JFS09	9/16"	9/16"	10.18
A-UM09/JFS12	9/16"	3/4"	13.92
A-UM12/JFS09	3/4"	9/16"	14.25
A-UM12/JFS12	3/4"	3/4"	11.43
A-UM12/JFS14	3/4"	7/8"	23.78
A-UM12/JFS17	3/4"	1.1/16"	29.95
A-UM14/JFS09	7/8"	9/16"	24.50
A-UM14/JFS12	7/8"	3/4"	15.30
A-UM14/JFS14	7/8"	7/8"	16.65
A-UM14/JFS17	7/8"	1.1/16"	30.00
A-UM17/JFS12	1.1/16"	3/4"	31.00
A-UM17/JFS14	1.1/16"	7/8"	30.50
A-UM17/JFS17	1.1/16"	1.1/16"	20.95
A-UM17/JFS21	1.1/16"	1.5/16"	50.00
A-UM21/JFS17	1.5/16"	1.1/16"	45.00
A-UM21/JFS21	1.5/16"	1.5/16"	32.03
A-UM26/JFS26	1.5/8"	1.5/8"	61.80
A-UM30/JFS30	1.7/8"	1.7/8"	66.00

ADAPTOR - STRAIGHT (M X F)

JIC Male x JIC Female (Expander) - Straight

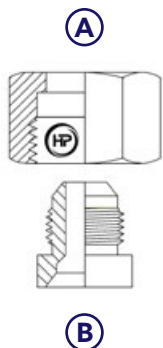

Part Number	A JIC (F)	B JIC (M)	List Price (\$)
A-JF06/JM07	3/8"	7/16"	12.32
A-JF07/JM09	7/16"	9/16"	17.35
A-JF07/JM12	7/16"	3/4"	18.95
A-JF09/JM08	9/16"	1/2"	17.60
A-JF09/JM12	9/16"	3/4"	16.45
A-JF12/JM14	3/4"	7/8"	12.70
A-JF12/JM17	3/4"	1.1/16"	19.30
A-JF12/JM21	3/4"	1.5/16"	27.30
A-JF14/JM12	7/8"	3/4"	17.80
A-JF14/JM17	7/8"	1.1/16"	21.28
A-JF17/JM14	1.1/16"	7/8"	19.25
A-JF17/JM21	1.1/16"	1.5/16"	22.75
A-JF21/JM26	1.5/16"	1.5/8"	59.97
A-JF21/JM30	1.5/16"	1.7/8"	62.00
A-JF26/JM30	1.5/8"	1.7/8"	95.73
A-JF30/JM40	1.7/8"	2.1/2"	160.32

ADAPTOR - STRAIGHT (M X F)

JIC Male x JIC Female Swivel - Straight

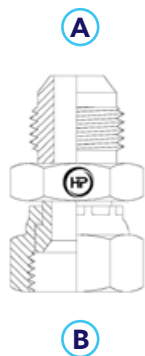

Part Number	A JIC (M)	B JIC (FS)	List Price (\$)
A-JM07/JFS07	7/16"	7/16"	11.75
A-JM09/JFS09	9/16"	9/16"	10.03
A-JM12/JFS12	3/4"	3/4"	12.97
A-JM14/JFS14	7/8"	7/8"	15.52
A-JM17/JFS17	1.1/16"	1.1/16"	21.82
A-JM21/JFS21	1.5/16"	1.5/16"	46.00
A-JM26/JFS26	1.5/8"	1.5/8"	48.45
A-JM30/JFS30	1.7/8"	1.7/8"	96.25

ADAPTOR - STRAIGHT (M X F)

BSPP Male x BSPP Female Swivel - Straight

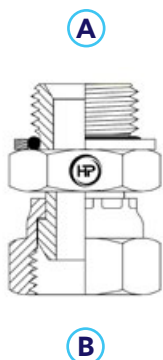

Part Number	A BSPP (M)	B BSPP (FS)	List Price (\$)
A-PM02/PFS02	1/8"	1/8"	11.95
A-PM04/PFS04	1/4"	1/4"	12.05
A-PM04/PFS06	1/4"	3/8"	15.00
A-PM06/PFS06	3/8"	3/8"	11.82
A-PM06/PFS08	3/8"	1/2"	16.43
A-PM08/PFS06	1/2"	3/8"	16.22
A-PM08/PFS08	1/2"	1/2"	15.48
A-PM08/PFS12	1/2"	3/4"	29.75
A-PM12/PFS12	3/4"	3/4"	21.88
A-PM12/PFS16	3/4"	1"	51.85
A-PM16/PFS12	1"	3/4"	45.45
A-PM16/PFS16	1"	1"	38.00
A-PM16/PFS20	1"	1.1/4"	92.00
A-PM20/PFS20	1.1/4"	1.1/4"	59.03

ADAPTOR - STRAIGHT (M X F)

Continued...

BSPT Male x BSPP Female Swivel - Straight

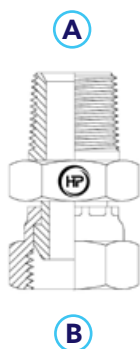

Part Number	A BSPT (M)	B BSPP (FS)	List Price (\$)
A-TM02/PFS02	1/8"	1/8"	9.13
A-TM02/PFS04	1/8"	1/4"	9.15
A-TM04/PFS02	1/4"	1/8"	9.21
A-TM04/PFS04	1/4"	1/4"	7.10
A-TM04/PFS06	1/4"	3/8"	8.40
A-TM04/PFS08	1/4"	1/2"	12.45
A-TM06/PFS04	3/8"	1/4"	13.45
A-TM06/PFS06	3/8"	3/8"	9.77

Continued on the following page...

ADAPTOR - STRAIGHT (M X F)

...Continued

BSPT Male x BSPP Female Swivel - Straight

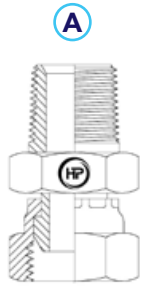

A-TM06/PFS08	3/8"	1/2"	13.67
A-TM08/PFS06	1/2"	3/8"	12.94
A-TM08/PFS08	1/2"	1/2"	11.88
A-TM08/PFS12	1/2"	3/4"	20.92
A-TM12/PFS08	3/4"	1/2"	19.13
A-TM12/PFS12	3/4"	3/4"	18.72
A-TM12/PFS16	3/4"	1"	29.10
A-TM16/PFS12	1"	3/4"	34.70
A-TM16/PFS16	1"	1"	26.93
A-TM16/PFS20	1"	1.1/4"	63.83
A-TM20/PFS16	1.1/4"	1"	99.90
A-TM20/PFS20	1.1/4"	1.1/4"	56.67
A-TM24/PFS24	1.1/2"	1.1/2"	99.23

ADAPTOR - STRAIGHT (M X F)

UNO Male x BSPP Female Swivel - Straight

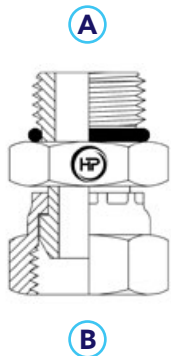

Part Number	A UNO (M)	B BSPP (FS)	List Price (\$)
A-UM09/PFS04	9/16"	1/4"	10.30
A-UM09/PFS06	9/16"	3/8"	10.75
A-UM09/PFS08	9/16"	1/2"	19.50
A-UM12/PFS06	3/4"	3/8"	12.40
A-UM12/PFS08	3/4"	1/2"	12.20
A-UM14/PFS06	7/8"	3/8"	19.45
A-UM14/PFS08	7/8"	1/2"	18.45
A-UM14/PFS12	7/8"	3/4"	29.36
A-UM17/PFS12	1.1/16"	3/4"	22.57
A-UM21/PFS16	1.5/16"	1"	33.36

ADAPTOR - STRAIGHT (F X F)

BSPT Female Fixed x BSPP Female Swivel - Straight

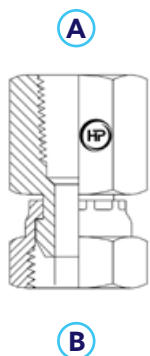

Part Number	A BSPT (F)	B BSPP (FS)	List Price (\$)
A-TF04/PFS04	1/4"	1/4"	14.58
A-TF06/PFS06	3/8"	3/8"	14.33
A-TF08/PFS06	1/2"	3/8"	19.90
A-TF08/PFS08	1/2"	1/2"	17.50
A-TF12/PFS12	3/4"	3/4"	31.57
A-TF16/PFS16	1"	1"	65.80

ADAPTOR - STRAIGHT (F X F)

BSPP Female x BSPP Female (Socket) - Straight Fixed

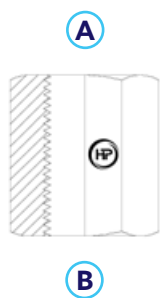

Part Number	(A) BSPP (F)	(B) BSPP (F)	List Price (\$)
A-PF04/PF04	1/4"	1/4"	7.50
A-PF06/PF06	3/8"	3/8"	8.03
A-PF08/PF08	1/2"	1/2"	11.88
A-PF12/PF12	3/4"	3/4"	13.65
A-PF16/PF16	1"	1"	25.70

ADAPTOR - STRAIGHT (F X F)

BSPT Female x BSPT Female (Socket) - Straight Fixed

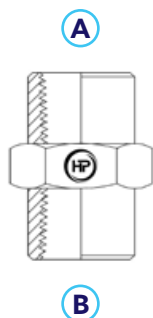

Part Number	(A) BSPT (F)	(B) BSPT (F)	List Price (\$)
A-TF02/TF02	1/8"	1/8"	6.73
A-TF04/TF02	1/4"	1/8"	7.90
A-TF04/TF04	1/4"	1/4"	6.62
A-TF06/TF04	3/8"	1/4"	8.48
A-TF06/TF06	3/8"	3/8"	6.85
A-TF08/TF04	1/2"	1/4"	15.37
A-TF08/TF06	1/2"	3/8"	11.05
A-TF08/TF08	1/2"	1/2"	7.90
A-TF12/TF08	3/4"	1/2"	14.85
A-TF12/TF12	3/4"	3/4"	12.87
A-TF16/TF12	1"	3/4"	21.55
A-TF16/TF16	1"	1"	19.30
A-TF20/TF16	1.1/4"	1"	29.00
A-TF20/TF20	1.1/4"	1.1/4"	29.13
A-TF24/TF24	1.1/2"	1.1/2"	53.41
A-TF32/TF32	2"	2"	81.27

ADAPTOR - STRAIGHT (F X F)

UNO Female x UNO Female (Socket) - Straight Fixed

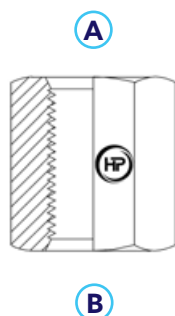

Part Number	(A) UNO (F)	(B) UNO (F)	List Price (\$)
A-UF07/UF07	7/16"	7/16"	10.20
A-UF09/UF09	9/16"	9/16"	22.73
A-UF12/UF12	3/4"	3/4"	14.35
A-UF14/UF14	7/8"	7/8"	18.70
A-UF17/UF17	1.1/16"	1.1/16"	24.45
A-UF21/UF21	1.5/16"	1.5/16"	27.30
A-UF26/UF26	1.5/8"	1.5/8"	60.00

JICM X BSPPM
90° ELBOW (M X M)

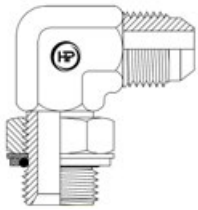

Page 36

JICM X BSPTM
90° ELBOW (M X M)

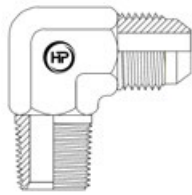

Page 36

JICM X UNOM
90° ELBOW (M X M)

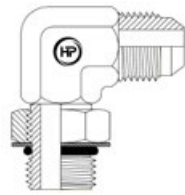

Page 37

JICM X UNOM
EXT. 90° ELBOW (M X M)

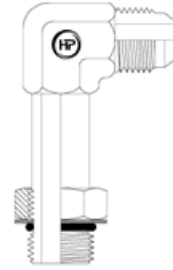

Page 38

JICM X JICM
90° ELBOW (M X M)



Page 38

BSPPM X BSPPM
90° ELBOW (M X M)

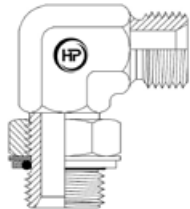

Page 39

BSPTM X BSPTM
90° ELBOW (M X M)

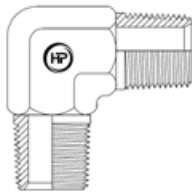

Page 39

BSPTM X BSPPM
90° ELBOW (M X M)

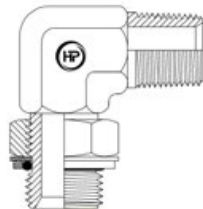

Page 39

BSPTM X UNOM
90° ELBOW (M X M)

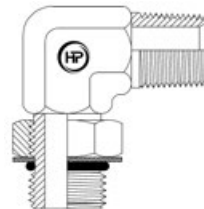

Page 40

UNOM X JICF
90° ELBOW (M X FS)

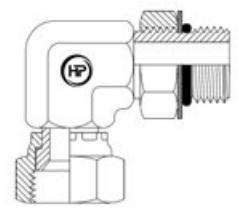

Page 40

JICM X JICF
90° ELBOW (M X FS)

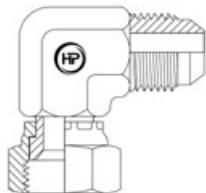

Page 41

JICM X JICF
90° BEND (M X FS)

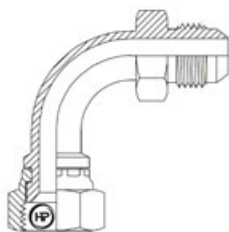

Page 41

JICM X JICF
90° LONG BEND (M X FS)

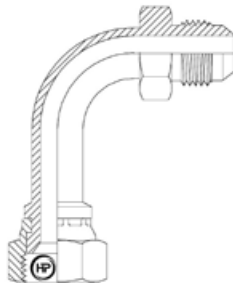

Page 41

BSPPM X BSPPF
90° ELBOW (M X FS)

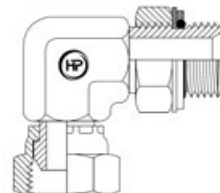

Page 42

BSPTM X BSPPF
90° ELBOW (M X FS)

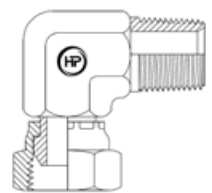

Page 42

UNOM X BSPPF
90° ELBOW (M X FS)

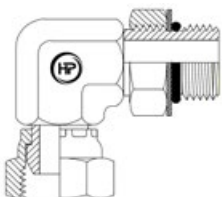

Page 42

BSPTM X BSPTF
90° FIXED ELBOW (M X F)

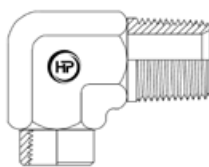

Page 43

BSPTF X BSPTF
90° FIXED ELBOW (F X F)

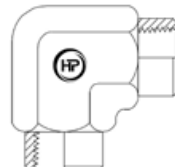

Page 43

For other sizes and thread types please contact us

ADAPTOR - 90° ELBOW (M X M)

JIC Male x BSPP Male - 90° Elbow

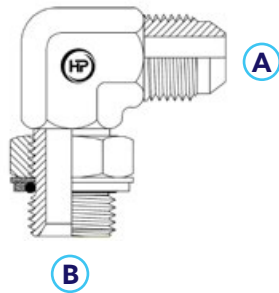

Part Number	A JIC (M)	B BSPP (M)	List Price (\$)
A-JM07/PM02-9	7/16"	1/8"	19.36
A-JM07/PM04-9	7/16"	1/4"	17.87
A-JM07/PM06-9	7/16"	3/8"	19.48
A-JM08/PM04-9	1/2"	1/4"	23.95
A-JM09/PM02-9	9/16"	1/8"	21.95
A-JM09/PM04-9	9/16"	1/4"	18.77
A-JM09/PM06-9	9/16"	3/8"	19.20
A-JM09/PM08-9	9/16"	1/2"	24.65
A-JM09/PM12-9	9/16"	3/4"	39.95
A-JM12/PM04-9	3/4"	1/4"	21.00
A-JM12/PM06-9	3/4"	3/8"	19.75
A-JM12/PM08-9	3/4"	1/2"	23.42
A-JM12/PM12-9	3/4"	3/4"	34.92
A-JM14/PM06-9	7/8"	3/8"	25.05
A-JM14/PM08-9	7/8"	1/2"	25.10
A-JM14/PM12-9	7/8"	3/4"	32.47
A-JM17/PM08-9	1.1/16"	1/2"	30.63
A-JM17/PM12-9	1.1/16"	3/4"	35.42
A-JM17/PM16-9	1.1/16"	1"	49.80
A-JM17/PM20-9	1.1/16"	1.1/4"	98.45
A-JM21/PM12-9	1.5/16"	3/4"	53.23
A-JM21/PM16-9	1.5/16"	1"	49.62
A-JM21/PM20-9	1.5/16"	1.1/4"	94.32
A-JM26/PM20-9	1.5/8"	1.1/4"	82.08
A-JM30/PM24-9	1.7/8"	1.1/2"	165.32

ADAPTOR - 90° ELBOW (M X M)

Continued...

JIC Male x BSPT Male - 90° Elbow

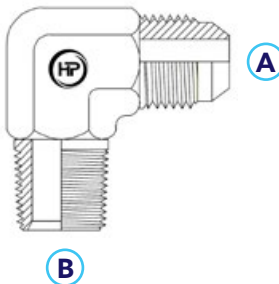

Part Number	A JIC (M)	B BSPT (M)	List Price (\$)
A-JM07/TM02-9	7/16"	1/8"	11.33
A-JM07/TM04-9	7/16"	1/4"	10.32
A-JM07/TM06-9	7/16"	3/8"	12.97
A-JM07/TM08-9	7/16"	1/2"	20.28
A-JM08/TM02-9	1/2"	1/8"	14.57
A-JM08/TM04-9	1/2"	1/4"	11.77
A-JM08/TM06-9	1/2"	3/8"	15.00
A-JM09/TM02-9	9/16"	1/8"	13.28
A-JM09/TM04-9	9/16"	1/4"	10.53
A-JM09/TM06-9	9/16"	3/8"	11.12
A-JM09/TM08-9	9/16"	1/2"	15.53

Continued on the following page...

ADAPTOR - 90° ELBOW (M X M)

...Continued

JIC Male x BSPT Male - 90° Elbow

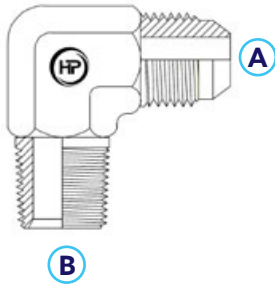

A-JM09/TM12-9	9/16"	3/4"	28.83
A-JM12/TM04-9	3/4"	1/4"	12.40
A-JM12/TM06-9	3/4"	3/8"	10.10
A-JM12/TM08-9	3/4"	1/2"	11.62
A-JM12/TM12-9	3/4"	3/4"	19.57
A-JM12/TM16-9	3/4"	1"	33.00
A-JM14/TM06-9	7/8"	3/8"	16.87
A-JM14/TM08-9	7/8"	1/2"	12.32
A-JM14/TM12-9	7/8"	3/4"	19.20
A-JM14/TM16-9	7/8"	1"	36.00
A-JM17/TM08-9	1.1/16"	1/2"	22.95
A-JM17/TM12-9	1.1/16"	3/4"	18.48
A-JM17/TM16-9	1.1/16"	1"	27.33
A-JM21/TM12-9	1.5/16"	3/4"	27.67
A-JM21/TM16-9	1.5/16"	1"	23.05
A-JM21/TM20-9	1.5/16"	1.1/4"	52.45
A-JM26/TM16-9	1.5/8"	1"	63.50
A-JM26/TM20-9	1.5/8"	1.1/4"	56.37
A-JM30/TM20-9	1.7/8"	1.1/4"	140.00
A-JM30/TM24-9	1.7/8"	1.1/2"	117.58
A-JM40/TM32-9	2.1/2"	2"	223.87

ADAPTOR - 90° ELBOW (M X M)

Continued...

JIC Male x UNO Male - 90° Elbow

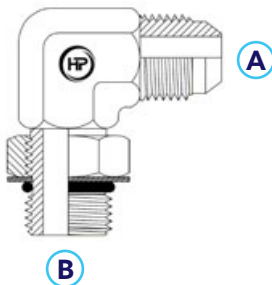

Part Number	A JIC (M)	B UNO (M)	List Price (\$)
A-JM07/UM08-9	7/16"	1/2"	20.38
A-JM07/UM09-9	7/16"	9/16"	16.30
A-JM07/UM12-9	7/16"	3/4"	14.45
A-JM09/UM07-9	9/16"	7/16"	14.47
A-JM09/UM08-9	9/16"	1/2"	27.10
A-JM09/UM09-9	9/16"	9/16"	12.95
A-JM09/UM12-9	9/16"	3/4"	15.27
A-JM09/UM14-9	9/16"	7/8"	22.23
A-JM09/UM17-9	9/16"	1.1/16"	34.02
A-JM12/UM09-9	3/4"	9/16"	16.73
A-JM12/UM12-9	3/4"	3/4"	14.25
A-JM12/UM14-9	3/4"	7/8"	18.02
A-JM12/UM17-9	3/4"	1.1/16"	29.23
A-JM12/UM21-9	3/4"	1.5/16"	46.25
A-JM14/UM12-9	7/8"	3/4"	18.75
A-JM14/UM14-9	7/8"	7/8"	18.43

Continued on the following page...

ADAPTOR - 90° ELBOW (M X M)

...Continued

JIC Male x UNO Male - 90° Elbow

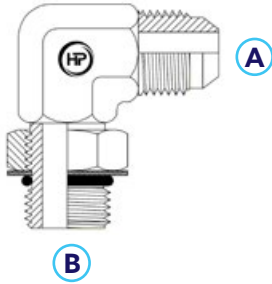

A-JM14/UM17-9	7/8"	1.1/16"	26.90
A-JM17/UM12-9	1.1/16"	3/4"	36.40
A-JM17/UM14-9	1.1/16"	7/8"	25.89
A-JM17/UM17-9	1.1/16"	1.1/16"	23.14
A-JM17/UM21-9	1.1/16"	1.5/16"	36.47
A-JM21/UM17-9	1.5/16"	1.1/16"	34.77
A-JM21/UM21-9	1.5/16"	1.5/16"	33.22
A-JM21/UM26-9	1.5/16"	1.5/8"	77.25
A-JM26/UM21-9	1.5/8"	1.5/16"	63.62
A-JM26/UM26-9	1.5/8"	1.5/8"	73.02
A-JM30/UM30-9	1.7/8"	1.7/8"	120.87
A-JM40/UM40-9	2.1/2"	2.1/2"	379.25

ADAPTOR - 90° ELBOW (M X M)

JIC Male x UNO Male - Extended 90° Elbow

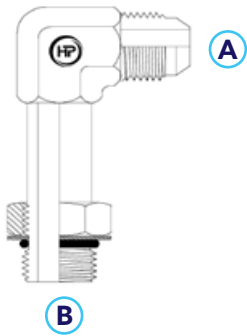

Part Number	A JIC (M)	B UNO (M)	List Price (\$)
A-JM09/UM09-9E	9/16"	9/16"	22.85
A-JM12/UM12-9E	3/4"	3/4"	33.50
A-JM12/UM14-9E	3/4"	7/8"	35.50
A-JM14/UM14-9E	7/8"	7/8"	32.00
A-JM17/UM17-9E	1.1/16"	1.1/16"	42.65
A-JM21/UM21-9E	1.5/16"	1.5/16"	58.00

ADAPTOR - 90° ELBOW (M X M)

JIC Male x JIC Male - 90° Elbow

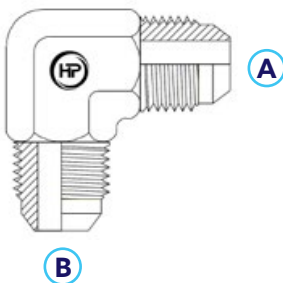

Part Number	A JIC (M)	B JIC (M)	List Price (\$)
A-JM07/JM07-9	7/16"	7/16"	9.37
A-JM08/JM08-9	1/2"	1/2"	12.73
A-JM09/JM09-9	9/16"	9/16"	9.90
A-JM12/JM09-9	3/4"	9/16"	14.59
A-JM12/JM12-9	3/4"	3/4"	9.37
A-JM14/JM12-9	7/8"	3/4"	16.82
A-JM14/JM14-9	7/8"	7/8"	13.88
A-JM17/JM14-9	1.1/16"	7/8"	21.20
A-JM17/JM17-9	1.1/16"	1.1/16"	17.30
A-JM21/JM17-9	1.5/16"	1.1/16"	31.00
A-JM21/JM21-9	1.5/16"	1.5/16"	28.87
A-JM26/JM26-9	1.5/8"	1.5/8"	69.55
A-JM30/JM30-9	1.7/8"	1.7/8"	111.47
A-JM40/JM40-9	2.1/2"	2.1/2"	182.00

ADAPTOR - 90° ELBOW (M X M)

BSPP Male x BSPP Male - 90° Elbow

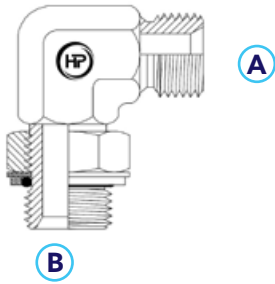

Part Number	A BSPP (M)	B BSPP (M)	List Price (\$)
A-PM12/PM12-9	3/4"	3/4"	64.26
A-PM16/PM16-9	1"	1"	90.09
A-PM20/PM20-9	1.1/4"	1.1/4"	270.48

ADAPTOR - 90° ELBOW (M X M)

BSPT Male x BSPT Male - 90° Elbow

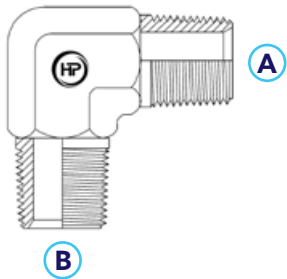

Part Number	A BSPT (M)	B BSPT (M)	List Price (\$)
A-TM02/TM02-9	1/8"	1/8"	8.10
A-TM04/TM02-9	1/4"	1/8"	9.92
A-TM04/TM04-9	1/4"	1/4"	9.58
A-TM06/TM04-9	3/8"	1/4"	11.57
A-TM06/TM06-9	3/8"	3/8"	11.18
A-TM08/TM04-9	1/2"	1/4"	12.65
A-TM08/TM06-9	1/2"	3/8"	16.17
A-TM08/TM08-9	1/2"	1/2"	13.57
A-TM12/TM08-9	3/4"	1/2"	21.42
A-TM12/TM12-9	3/4"	3/4"	19.42
A-TM16/TM12-9	1"	3/4"	29.47
A-TM16/TM16-9	1"	1"	28.18
A-TM20/TM12-9	1.1/4"	3/4"	63.40
A-TM20/TM16-9	1.1/4"	1"	52.33
A-TM20/TM20-9	1.1/4"	1.1/4"	51.93
A-TM24/TM24-9	1.1/2"	1.1/2"	110.03
A-TM32/TM32-9	2"	2"	235.43

ADAPTOR - 90° ELBOW (M X M)

Continued...

BSPT Male x BSPP Male - 90° Elbow

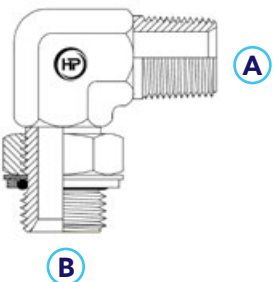

Part Number	A BSPT (M)	B BSPP (M)	List Price (\$)
A-TM04/PM04-9	1/4"	1/4"	20.28
A-TM04/PM06-9	1/4"	3/8"	25.25
A-TM06/PM06-9	3/8"	3/8"	21.85
A-TM06/PM08-9	3/8"	1/2"	41.45
A-TM08/PM06-9	1/2"	3/8"	33.23
A-TM08/PM08-9	1/2"	1/2"	29.70
A-TM08/PM12-9	1/2"	3/4"	52.20
A-TM12/PM08-9	3/4"	1/2"	39.95
A-TM12/PM12-9	3/4"	3/4"	36.70

Continued on the following page...

ADAPTOR - 90° ELBOW (M X M)

Continued...

BSPT Male x BSPP Male - 90° Elbow

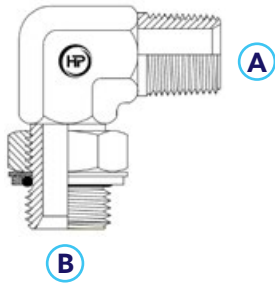

A-TM12/PM16-9	3/4"	1"	71.42
A-TM16/PM12-9	1"	3/4"	66.75
A-TM16/PM16-9	1"	1"	61.78
A-TM16/PM20-9	1"	1.1/4"	120.75
A-TM20/PM20-9	1.1/4"	1.1/4"	108.53
A-TM24/PM24-9	1.1/2"	1.1/2"	130.89

ADAPTOR - 90° ELBOW (M X M)

BSPT Male x UNO Male - 90° Elbow

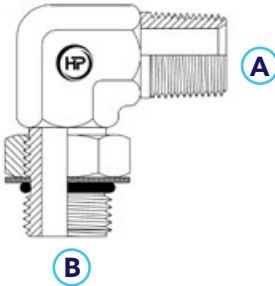

Part Number	A BSPT (M)	B UNO (M)	List Price (\$)
A-TM04/UM07-9	1/4"	7/16"	12.50
A-TM04/UM09-9	1/4"	9/16"	12.58
A-TM04/UM12-9	1/4"	3/4"	22.95
A-TM06/UM09-9	3/8"	9/16"	16.85
A-TM06/UM12-9	3/8"	3/4"	22.95
A-TM06/UM14-9	3/8"	7/8"	26.50
A-TM08/UM12-9	1/2"	3/4"	22.95
A-TM08/UM14-9	1/2"	7/8"	26.10
A-TM08/UM17-9	1/2"	1.1/16"	27.70
A-TM12/UM14-9	3/4"	7/8"	27.90
A-TM12/UM17-9	3/4"	1.1/16"	26.90
A-TM12/UM21-9	3/4"	1.5/16"	55.80
A-TM16/UM17-9	1"	1.1/16"	56.60
A-TM16/UM21-9	1"	1.5/16"	54.40
A-TM16/UM26-9	1"	1.5/8"	68.80
A-TM20/UM26-9	1.1/4"	1.5/8"	69.50

ADAPTOR - 90° ELBOW (M X F)

UNO Male x JIC Female Swivel - 90° Elbow

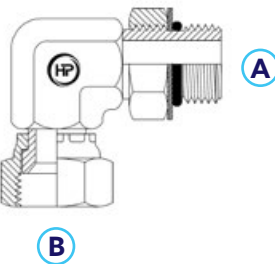

Part Number	A UNO (M)	B JIC (FS)	List Price (\$)
A-UM07/JFS07-9	7/16"	7/16"	25.25
A-UM09/JFS09-9	9/16"	9/16"	21.82
A-UM12/JFS12-9	3/4"	3/4"	26.07
A-UM12/JFS14-9	3/4"	7/8"	31.85
A-UM14/JFS14-9	7/8"	7/8"	32.93
A-UM17/JFS17-9	1.1/16"	1.1/16"	41.55
A-UM21/JFS21-9	1.5/16"	1.5/16"	83.40

ADAPTOR - 90° ELBOW (M X F)

JIC Male x JIC Female Swivel - 90° Elbow

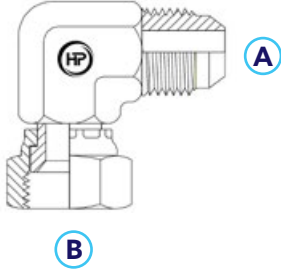

Part Number	A JIC (M)	B JIC (FS)	List Price (\$)
A-JM07/JFS07-9	7/16"	7/16"	10.98
A-JM08/JFS08-9	1/2"	1/2"	14.10
A-JM09/JFS09-9	9/16"	9/16"	12.33
A-JM09/JFS12-9	9/16"	3/4"	16.15
A-JM12/JFS09-9	3/4"	9/16"	16.10
A-JM12/JFS12-9	3/4"	3/4"	15.35
A-JM12/JFS14-9	3/4"	7/8"	24.95
A-JM14/JFS14-9	7/8"	7/8"	18.10
A-JM14/JFS17-9	7/8"	1.1/16"	28.10
A-JM17/JFS14-9	1.1/16"	7/8"	23.50
A-JM17/JFS17-9	1.1/16"	1.1/16"	22.70
A-JM21/JFS21-9	1.5/16"	1.5/16"	42.53
A-JM26/JFS26-9	1.5/8"	1.5/8"	81.97
A-JM30/JFS30-9	1.7/8"	1.7/8"	196.52
A-JM40/JFS40-9	2.1/2"	2.1/2"	299.18

ADAPTOR - 90° ELBOW (M X F)

JIC Male x JIC Female Swivel - 90° Bend

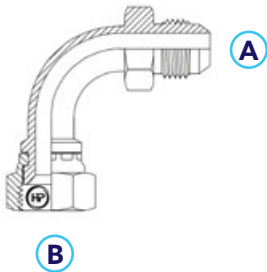

Part Number	A JIC (M)	B JIC (FS)	List Price (\$)
A-JM07/JFS07-9B	7/16"	7/16"	19.30
A-JM09/JFS09-9B	9/16"	9/16"	24.97
A-JM12/JFS12-9B	3/4"	3/4"	31.62
A-JM14/JFS14-9B	7/8"	7/8"	39.90
A-JM17/JFS17-9B	1.1/16"	1.1/16"	56.98
A-JM21/JFS21-9B	1.5/16"	1.5/16"	63.35
A-JM26/JFS26-9B	1.5/8"	1.5/8"	128.56
A-JM30/JFS30-9B	1.7/8"	1.7/8"	216.90
A-JM40/JFS40-9B	2.1/2"	2.1/2"	381.45

ADAPTOR - 90° ELBOW (M X F)

JIC Male x JIC Female Swivel - 90° Long Bend

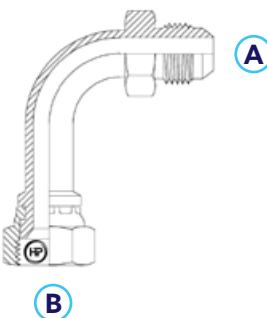

Part Number	A JIC (M)	B JIC (FS)	List Price (\$)
A-JM07/JFS07-9L	7/16"	7/16"	30.10
A-JM09/JFS09-9L	9/16"	9/16"	33.28
A-JM12/JFS12-9L	3/4"	3/4"	39.40
A-JM14/JFS14-9L	7/8"	7/8"	46.23
A-JM17/JFS17-9L	1.1/16"	1.1/16"	56.65
A-JM21/JFS21-9L	1.5/16"	1.5/16"	90.17
A-JM26/JFS26-9L	1.5/8"	1.5/8"	142.30

ADAPTOR - 90° ELBOW (M X F)

BSPP Male x BSPP Female Swivel - 90° Elbow

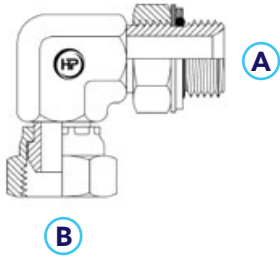

Part Number	A BSPP (M)	B BSPP (FS)	List Price (\$)
A-PM04/PFS04-9	1/4"	1/4"	37.60
A-PM06/PFS06-9	3/8"	3/8"	40.68
A-PM08/PFS08-9	1/2"	1/2"	47.65
A-PM12/PFS12-9	3/4"	3/4"	61.33
A-PM16/PFS16-9	1"	1"	81.53
A-PM20/PFS20-9	1.1/4"	1.1/4"	242.40

ADAPTOR - 90° ELBOW (M X F)

BSPT Male x BSPP Female Swivel - 90° Elbow

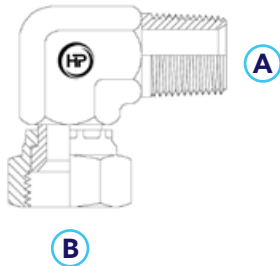

Part Number	A BSPT (M)	B BSPP (FS)	List Price (\$)
A-TM02/PFS02-9	1/8"	1/8"	12.45
A-TM04/PFS04-9	1/4"	1/4"	13.83
A-TM06/PFS04-9	3/8"	1/4"	21.57
A-TM06/PFS06-9	3/8"	3/8"	16.75
A-TM06/PFS08-9	3/8"	1/2"	22.57
A-TM08/PFS06-9	1/2"	3/8"	25.55
A-TM08/PFS08-9	1/2"	1/2"	17.82
A-TM08/PFS12-9	1/2"	3/4"	60.98
A-TM12/PFS12-9	3/4"	3/4"	26.47
A-TM16/PFS16-9	1"	1"	37.57
A-TM20/PFS20-9	1.1/4"	1.1/4"	107.95
A-TM24/PFS24-9	1.1/2"	1.1/2"	165.10

ADAPTOR - 90° ELBOW (M X F)

UNO Male x BSPP Female Swivel - 90° Elbow

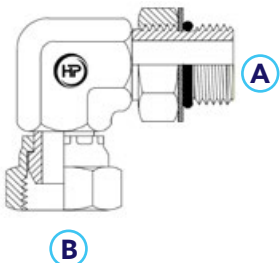

Part Number	A UNO (M)	B BSPP (FS)	List Price (\$)
A-UM07/PFS02-9	7/16"	1/8"	38.20
A-UM07/PFS04-9	7/16"	1/4"	39.00
A-UM09/PFS04-9	9/16"	1/4"	47.45
A-UM09/PFS06-9	9/16"	3/8"	38.00
A-UM12/PFS06-9	3/4"	3/8"	35.50
A-UM12/PFS08-9	3/4"	1/2"	32.05
A-UM14/PFS08-9	7/8"	1/2"	36.40
A-UM17/PFS12-9	1.1/16"	3/4"	51.95
A-UM21/PFS16-9	1.5/16"	1"	67.30

ADAPTOR - 90° ELBOW (M X F)

BSPT Male x BSPT Female - 90° Elbow Fixed

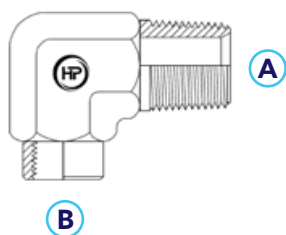

Part Number	A BSPT (M)	B BSPT (F)	List Price (\$)
A-TM02/TF02-9	1/8"	1/8"	11.02
A-TM04/TF04-9	1/4"	1/4"	12.73
A-TM06/TF06-9	3/8"	3/8"	13.53
A-TM08/TF08-9	1/2"	1/2"	17.03
A-TM12/TF12-9	3/4"	3/4"	27.12
A-TM16/TF16-9	1"	1"	55.13
A-TM20/TF20-9	1.1/4"	1.1/4"	96.38

ADAPTOR - 90° ELBOW (F X F)

BSPT Female x BSPT Female - 90° Elbow Fixed

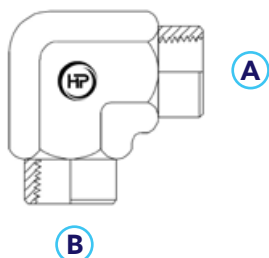

Part Number	A BSPT (F)	B BSPT (F)	List Price (\$)
A-TF02/TF02-9	1/8"	1/8"	11.38
A-TF04/TF04-9	1/4"	1/4"	14.43
A-TF06/TF06-9	3/8"	3/8"	15.28
A-TF08/TF08-9	1/2"	1/2"	23.08
A-TF12/TF12-9	3/4"	3/4"	28.30
A-TF16/TF16-9	1"	1"	53.40
A-TF20/TF20-9	1.1/4"	1.1/4"	117.98
A-TF24/TF24-9	1.1/2"	1.1/2"	182.80
A-TF32/TF32-9	2"	2"	451.25

JICM X BSPPM
45° ELBOW (M X M)

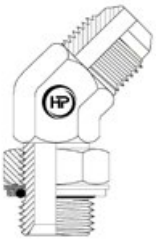

Page 45

JICM X BSPTM
45° ELBOW (M X M)

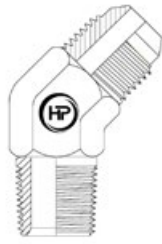

Page 45

JICM X UNOM
45° ELBOW (M X M)

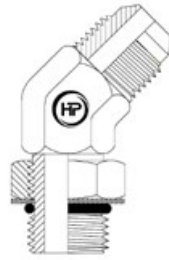

Page 46

JICM X JICM
45° ELBOW (M X M)



Page 46

BSPTM X BSPTM
45° ELBOW (M X M)

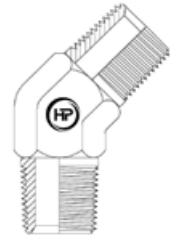

Page 46

BSPTM X UNOM
45° ELBOW (M X M)

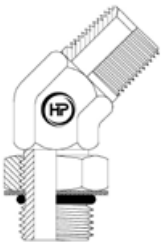

Page 47

JICM X JICF
45° ELBOW (M X F)

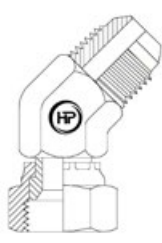

Page 47

JICM X JICF
45° BEND (M X F)

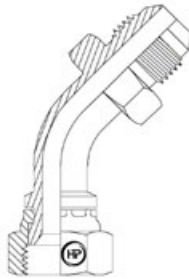

Page 47

BSPTM X BSPPF
45° ELBOW (M X F)

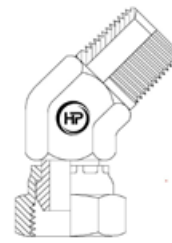

Page 48

BSPTM X BSPTF
REDUCING BUSH (M X F)

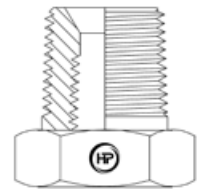

Page 48

BSPPM X BSPPF
REDUCING BUSH (M X F)

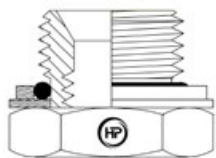

Page 49

UNOM X BSPTF
REDUCING BUSH (M X F)

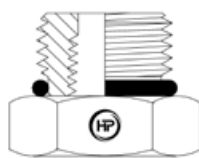

Page 49

For other sizes and thread types please contact us

ADAPTOR - 45° ELBOW (M X M)

JIC Male x BSPP Male - 45° Elbow

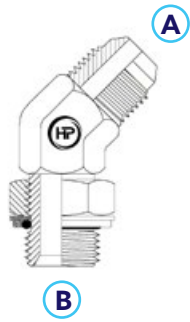

Part Number	A JIC (M)	B BSPP (M)	List Price (\$)
A-JM07/PM04-4	7/16"	1/4"	25.55
A-JM07/PM06-4	7/16"	3/8"	44.52
A-JM09/PM04-4	9/16"	1/4"	25.83
A-JM09/PM06-4	9/16"	3/8"	29.97
A-JM09/PM08-4	9/16"	1/2"	36.23
A-JM12/PM06-4	3/4"	3/8"	26.10
A-JM12/PM08-4	3/4"	1/2"	35.05
A-JM14/PM08-4	7/8"	1/2"	36.02
A-JM14/PM12-4	7/8"	3/4"	40.00
A-JM17/PM12-4	1.1/16"	3/4"	45.77
A-JM21/PM16-4	1.5/16"	1"	57.48

ADAPTOR - 45° ELBOW (M X M)

JIC Male x BSPT Male - 45° Elbow



Part Number	A JIC (M)	B BSPT (M)	List Price (\$)
A-JM07/TM02-4	7/16"	1/8"	12.80
A-JM07/TM04-4	7/16"	1/4"	14.08
A-JM08/TM04-4	1/2"	1/4"	37.55
A-JM09/TM02-4	9/16"	1/8"	15.88
A-JM09/TM04-4	9/16"	1/4"	15.72
A-JM09/TM06-4	9/16"	3/8"	19.72
A-JM09/TM08-4	9/16"	1/2"	24.87
A-JM12/TM04-4	3/4"	1/4"	25.33
A-JM12/TM06-4	3/4"	3/8"	20.33
A-JM12/TM08-4	3/4"	1/2"	23.43
A-JM12/TM12-4	3/4"	3/4"	44.60
A-JM14/TM06-4	7/8"	3/8"	27.28
A-JM14/TM08-4	7/8"	1/2"	25.07
A-JM14/TM12-4	7/8"	3/4"	33.30
A-JM17/TM08-4	1.1/16"	1/2"	34.53
A-JM17/TM12-4	1.1/16"	3/4"	30.90
A-JM21/TM12-4	1.5/16"	3/4"	47.95
A-JM21/TM16-4	1.5/16"	1"	38.67
A-JM26/TM20-4	1.5/8"	1.1/4"	73.28
A-JM30/TM24-4	1.7/8"	1.1/2"	166.25

ADAPTOR - 45° ELBOW (M X M)

JIC Male x UNO Male - 45° Elbow

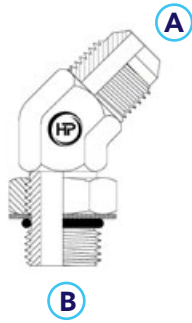

Part Number	A JIC (M)	B UNO (M)	List Price (\$)
A-JM07/UM07-4	7/16"	7/16"	17.08
A-JM07/UM09-4	7/16"	9/16"	22.80
A-JM09/UM09-4	9/16"	9/16"	21.33
A-JM09/UM12-4	9/16"	3/4"	25.72
A-JM12/UM09-4	3/4"	9/16"	25.37
A-JM12/UM12-4	3/4"	3/4"	27.45
A-JM12/UM14-4	3/4"	7/8"	29.00
A-JM12/UM17-4	3/4"	1.1/16"	36.53
A-JM14/UM12-4	7/8"	3/4"	28.67
A-JM14/UM14-4	7/8"	7/8"	30.53
A-JM17/UM17-4	1.1/16"	1.1/16"	32.58
A-JM21/UM21-4	1.5/16"	1.5/16"	53.30
A-JM26/UM26-4	1.5/8"	1.5/8"	86.90
A-JM30/UM30-4	1.7/8"	1.7/8"	176.48

ADAPTOR - 45° ELBOW (M X M)

JIC Male x JIC Male - 45° Elbow

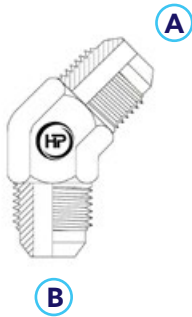

Part Number	A JIC (M)	B JIC (M)	List Price (\$)
A-JM07/JM07-4	7/16"	7/16"	9.52
A-JM08/JM08-4	1/2"	1/2"	25.13
A-JM09/JM09-4	9/16"	9/16"	9.52
A-JM12/JM12-4	3/4"	3/4"	12.11
A-JM14/JM14-4	7/8"	7/8"	14.28
A-JM17/JM17-4	1.1/16"	1.1/16"	28.56
A-JM21/JM21-4	1.5/16"	1.5/16"	33.60
A-JM26/JM26-4	1.5/8"	1.5/8"	110.74

ADAPTOR - 45° ELBOW (M X M)

BSPT Male x BSPT Male - 45° Elbow

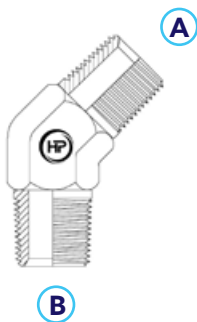

Part Number	A BSPT (M)	B BSPT (M)	List Price (\$)
A-TM02/TM02-4	1/8"	1/8"	19.03
A-TM04/TM04-4	1/4"	1/4"	16.05
A-TM06/TM04-4	3/8"	1/4"	15.80
A-TM06/TM06-4	3/8"	3/8"	15.55
A-TM08/TM06-4	1/2"	3/8"	26.13
A-TM08/TM08-4	1/2"	1/2"	20.10
A-TM12/TM08-4	3/4"	1/2"	33.18
A-TM12/TM12-4	3/4"	3/4"	28.03
A-TM16/TM12-4	1"	3/4"	45.67
A-TM16/TM16-4	1"	1"	36.03

ADAPTOR - 45° ELBOW (M X M)

BSPT Male x UNO Male - 45° Elbow

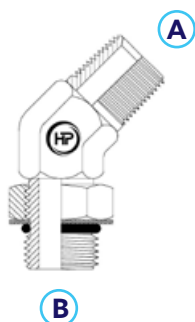

Part Number	A BSPT (M)	B UNO (M)	List Price (\$)
A-TM04/UM09-4	1/4"	9/16"	20.00
A-TM06/UM09-4	3/8"	9/16"	24.00
A-TM06/UM12-4	3/8"	3/4"	26.00
A-TM08/UM12-4	1/2"	3/4"	29.00
A-TM08/UM14-4	1/2"	7/8"	38.32
A-TM12/UM17-4	3/4"	1.1/16"	35.00
A-TM16/UM21-4	1"	1.5/16"	50.00

ADAPTOR - 45° ELBOW (M X F)

JIC Male x JIC Female Swivel - 45° Elbow

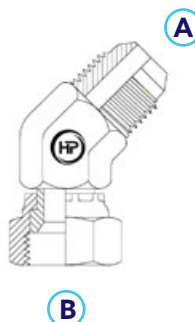

Part Number	A JIC (M)	B JIC (FS)	List Price (\$)
A-JM07/JFS07-4	7/16"	7/16"	18.58
A-JM08/JFS08-4	1/2"	1/2"	21.83
A-JM09/JFS09-4	9/16"	9/16"	15.12
A-JM12/JFS12-4	3/4"	3/4"	17.87
A-JM14/JFS14-4	7/8"	7/8"	22.58
A-JM17/JFS17-4	1.1/16"	1.1/16"	25.42
A-JM21/JFS21-4	1.5/16"	1.5/16"	37.45
A-JM26/JFS26-4	1.5/8"	1.5/8"	88.52
A-JM30/JFS30-4	1.7/8"	1.7/8"	127.30
A-JM40/JFS40-4	2.1/2"	2.1/2"	280.37

ADAPTOR - 45° ELBOW (M X F)

JIC Male x JIC Female Swivel - 45° Bend

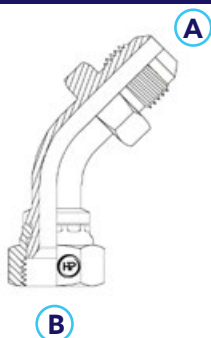

Part Number	A JIC (M)	B JIC (FS)	List Price (\$)
A-JM09/JFS09-4B	9/16"	9/16"	37.17
A-JM12/JFS12-4B	3/4"	3/4"	42.08
A-JM14/JFS14-4B	7/8"	7/8"	49.23
A-JM17/JFS17-4B	1.1/16"	1.1/16"	51.68
A-JM21/JFS21-4B	1.5/16"	1.5/16"	70.30
A-JM26/JFS26-4B	1.5/8"	1.5/8"	106.20

ADAPTOR - 45° ELBOW (M X F)

BSPT Male x BSPP Female Swivel - 45° Elbow

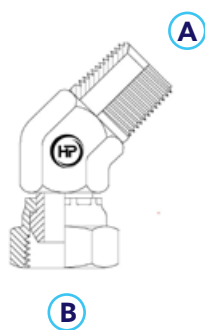

Part Number	A BSPT (M)	B BSPP (FS)	List Price (\$)
A-TM02/PFS02-4	1/8"	1/8"	18.45
A-TM04/PFS04-4	1/4"	1/4"	16.43
A-TM06/PFS06-4	3/8"	3/8"	20.73
A-TM08/PFS08-4	1/2"	1/2"	26.42
A-TM12/PFS12-4	3/4"	3/4"	41.87
A-TM16/PFS16-4	1"	1"	51.20
A-TM20/PFS20-4	1.1/4"	1.1/4"	98.21
A-TM24/PFS24-4	1.1/2"	1.1/2"	139.60

ADAPTOR - REDUCING BUSH

BSPT Male x BSPT Female - Reducing Bush

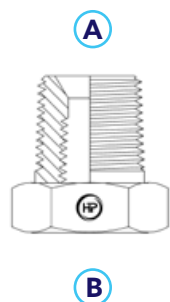

Part Number	A BSPT (M)	B BSPT (F)	List Price (\$)
A-TM04/TF02	1/4"	1/8"	8.10
A-TM06/TF02	3/8"	1/8"	5.54
A-TM06/TF04	3/8"	1/4"	4.62
A-TM08/TF02	1/2"	1/8"	9.45
A-TM08/TF04	1/2"	1/4"	6.85
A-TM08/TF06	1/2"	3/8"	4.88
A-TM12/TF04	3/4"	1/4"	8.90
A-TM12/TF06	3/4"	3/8"	8.55
A-TM12/TF08	3/4"	1/2"	8.28
A-TM16/TF06	1"	3/8"	20.25
A-TM16/TF08	1"	1/2"	11.03
A-TM16/TF12	1"	3/4"	11.58
A-TM20/TF08	1.1/4"	1/2"	27.38
A-TM20/TF12	1.1/4"	3/4"	20.76
A-TM20/TF16	1.1/4"	1"	23.31
A-TM24/TF08	1.1/2"	1/2"	30.00
A-TM24/TF12	1.1/2"	3/4"	30.30
A-TM24/TF16	1.1/2"	1"	31.23
A-TM24/TF20	1.1/2"	1.1/4"	32.15
A-TM32/TF16	2"	1"	58.93
A-TM32/TF20	2"	1.1/4"	56.53
A-TM32/TF24	2"	1.1/2"	56.53

ADAPTOR - REDUCING BUSH

BSPP Male x BSPP Female - Reducing Bush

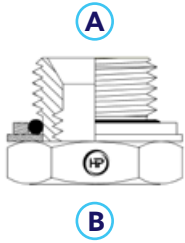

Part Number	A BSPP (M)	B BSPP (F)	List Price (\$)
A-PM04/PF02	1/4"	1/8"	16.57
A-PM06/PF04	3/8"	1/4"	13.52
A-PM08/PF04	1/2"	1/4"	13.90
A-PM08/PF06	1/2"	3/8"	14.54
A-PM12/PF04	3/4"	1/4"	20.75
A-PM12/PF06	3/4"	3/8"	16.40
A-PM12/PF08	3/4"	1/2"	14.25
A-PM16/PF08	1"	1/2"	22.69
A-PM16/PF12	1"	3/4"	31.98
A-PM20/PF08	1.1/4"	1/2"	42.00
A-PM20/PF12	1.1/4"	3/4"	63.12
A-PM20/PF16	1.1/4"	1"	41.13
A-PM24/PF16	1.1/2"	1"	68.97
A-PM24/PF20	1.1/2"	1.1/4"	72.63
A-PM32/PF24	2"	1.1/2"	135.68

ADAPTOR - REDUCING BUSH

UNO Male x BSPT Female - Reducing Bush

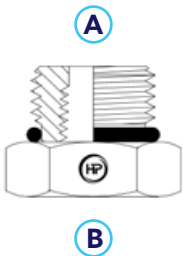

Part Number	A UNO (M)	B BSPT (F)	List Price (\$)
A-UM09/TF02	9/16"	1/8"	14.00
A-UM12/TF02	3/4"	1/8"	32.70
A-UM12/TF04	3/4"	1/4"	49.10
A-UM12/TF06	3/4"	3/8"	48.50
A-UM14/TF04	7/8"	1/4"	54.20
A-UM14/TF06	7/8"	3/8"	53.50
A-UM17/TF08	1.1/16"	1/2"	26.75
A-UM21/TF08	1.5/16"	1/2"	47.15
A-UM21/TF12	1.5/16"	3/4"	87.60
A-UM26/TF12	1.5/8"	3/4"	90.65

JICM X BSPPM X JICM
RUN TEE

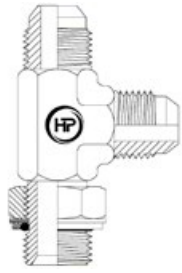

Page 51

JICM X BSPTM X JICM
RUN TEE

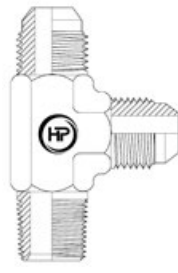

Page 51

JICM X UNOM X JICM
RUN TEE

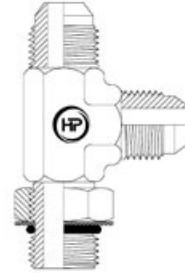

Page 51

JICM X JICF X JICM
RUN TEE

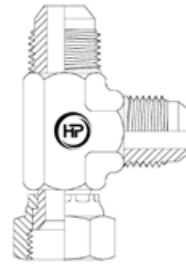

Page 52

BSPPM X BSPPF X BSPPM
RUN TEE

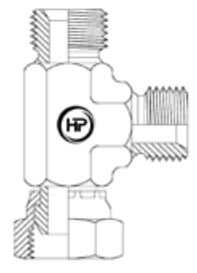

Page 52

BSPTM X BSPPF X BSPTM
RUN TEE

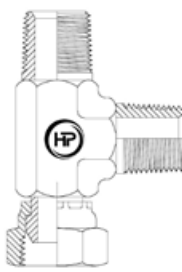

Page 52

BSPTM X BSPPM X BSPTM
RUN TEE

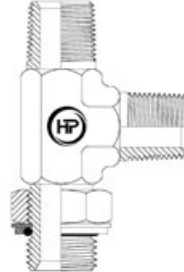

Page 53

BSPTM X BSPTF X BSPTF
RUN TEE

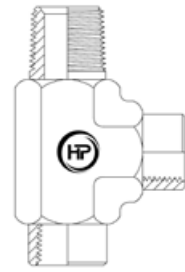

Page 53

JICM X JICM X BSPPM
BRANCH TEE

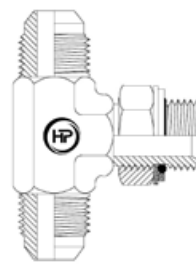

Page 53

JICM X JICM X BSPTM
BRANCH TEE

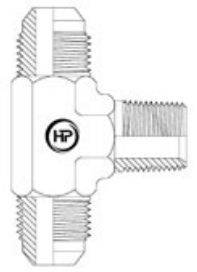

Page 54

JICM X JICM X UNOM
BRANCH TEE

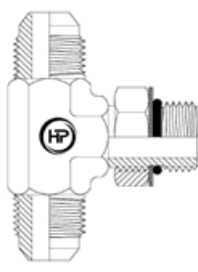

Page 54

JICM X JICM X JICF
BRANCH TEE

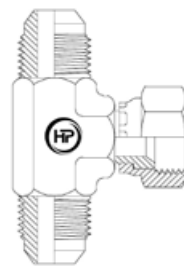

Page 54

BSPPF X BSPPF X BSPTM
BRANCH TEE

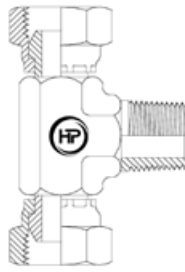

Page 55

BSPTM X BSPTM X BSPPF
BRANCH TEE

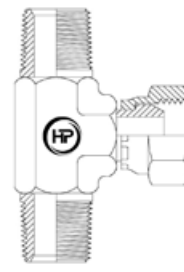

Page 55

JICM X JICM X JICM
EQUAL TEE

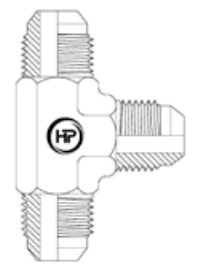

Page 55

BSPPF X BSPPF X BSPPF
EQUAL TEE

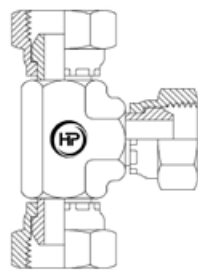

Page 56

BSPTM X BSPTM X BSPTM
EQUAL TEE

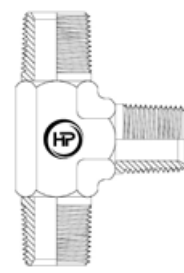

Page 56

BSPTF X BSPTF X BSPTF
EQUAL TEE

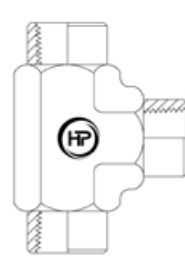

Page 56

For other sizes and thread types please contact us

ADAPTOR - RUN TEE

JIC Male x BSPP Male x JIC Male - Run Tee

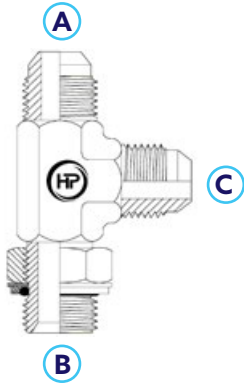

Part Number	A JIC (M)	B BSPP (M)	C JIC (M)	List Price (\$)
A-JM07/PM04/JM07	7/16"	1/4"	7/16"	32.83
A-JM09/PM04/JM09	9/16"	1/4"	9/16"	30.97
A-JM09/PM06/JM09	9/16"	3/8"	9/16"	35.30
A-JM12/PM06/JM12	3/4"	3/8"	3/4"	34.77
A-JM12/PM08/JM12	3/4"	1/2"	3/4"	48.25
A-JM14/PM08/JM14	7/8"	1/2"	7/8"	43.47
A-JM17/PM12/JM17	1.1/16"	3/4"	1.1/16"	58.40
A-JM21/PM16/JM21	1.5/16"	1"	1.5/16"	95.83
A-JM26/PM20/JM26	1.5/8"	1.1/4"	1.5/8"	185.50

ADAPTOR - RUN TEE

JIC Male x BSPT Male x JIC Male - Run Tee

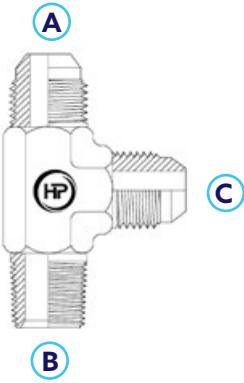

Part Number	A JIC (M)	B BSPT (M)	C JIC (M)	List Price (\$)
A-JM07/TM02/JM07	7/16"	1/8"	7/16"	23.93
A-JM07/TM04/JM07	7/16"	1/4"	7/16"	30.00
A-JM09/TM04/JM09	9/16"	1/4"	9/16"	24.87
A-JM09/TM06/JM09	9/16"	3/8"	9/16"	33.28
A-JM12/TM06/JM12	3/4"	3/8"	3/4"	29.48
A-JM12/TM08/JM12	3/4"	1/2"	3/4"	32.67
A-JM14/TM08/JM14	7/8"	1/2"	7/8"	33.17
A-JM17/TM12/JM17	1.1/16"	3/4"	1.1/16"	45.80
A-JM21/TM16/JM21	1.5/16"	1"	1.5/16"	68.90

ADAPTOR - RUN TEE

JIC Male x UNO Male x JIC Male - Run Tee

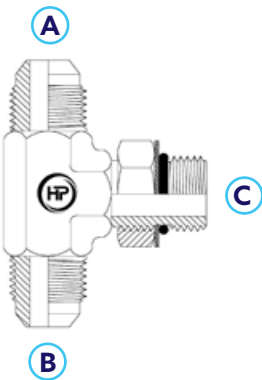

Part Number	A JIC (M)	B UNO (M)	C JIC (M)	List Price (\$)
A-JM07/UM07/JM07	7/16"	7/16"	7/16"	23.53
A-JM09/UM09/JM09	9/16"	9/16"	9/16"	20.15
A-JM12/UM12/JM12	3/4"	3/4"	3/4"	25.13
A-JM12/UM14/JM12	3/4"	7/8"	3/4"	30.50
A-JM14/UM14/JM12	7/8"	7/8"	3/4"	30.30
A-JM14/UM14/JM14	7/8"	7/8"	7/8"	29.57
A-JM17/UM17/JM17	1.1/16"	1.1/16"	1.1/16"	43.10
A-JM21/UM21/JM21	1.5/16"	1.5/16"	1.5/16"	72.42
A-JM26/UM26/JM26	1.5/8"	1.5/8"	1.5/8"	110.03

ADAPTOR - RUN TEE

JIC Male x JIC Female Swivel x JIC Male - Run Tee

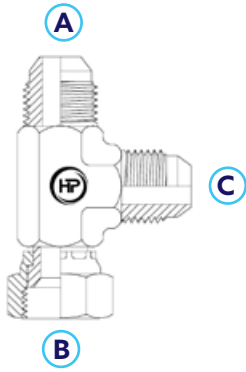

Part Number	A JIC (M)	B JIC (FS)	C JIC (M)	List Price (\$)
A-JM07/JFS07/JM07	7/16"	7/16"	7/16"	14.98
A-JM08/JFS08/JM08	1/2"	1/2"	1/2"	22.25
A-JM09/JFS09/JM09	9/16"	9/16"	9/16"	15.60
A-JM12/JFS12/JM12	3/4"	3/4"	3/4"	18.53
A-JM14/JFS14/JM14	7/8"	7/8"	7/8"	21.63
A-JM17/JFS17/JM17	1.1/16"	1.1/16"	1.1/16"	29.10
A-JM21/JFS21/JM21	1.5/16"	1.5/16"	1.5/16"	51.80
A-JM26/JFS26/JM26	1.5/8"	1.5/8"	1.5/8"	99.30
A-JM30/JFS30/JM30	1.7/8"	1.7/8"	1.7/8"	150.18

ADAPTOR - RUN TEE

BSPP Male x BSPP Female Swivel x BSPP Male - Run Tee

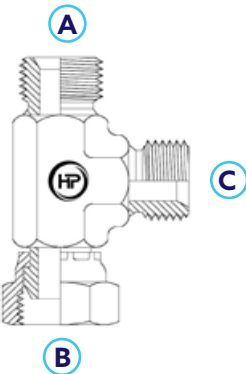

Part Number	A BSPP (M)	B BSPP (FS)	C BSPP (M)	List Price (\$)
A-PM04/PFS04/PM04	1/4"	1/4"	1/4"	49.90
A-PM06/PFS06/PM06	3/8"	3/8"	3/8"	49.90
A-PM08/PFS08/PM08	1/2"	1/2"	1/2"	60.10

ADAPTOR - RUN TEE

BSPT Male x BSPP Female Swivel x BSPT Male - Run Tee

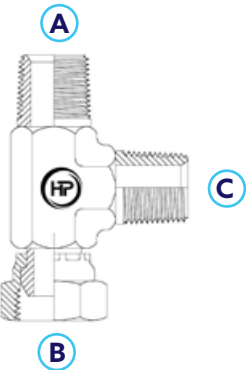

Part Number	A BSPT (M)	B BSPP (FS)	C BSPT (M)	List Price (\$)
A-TM02/PFS02/TM02	1/8"	1/8"	1/8"	19.48
A-TM04/PFS04/TM04	1/4"	1/4"	1/4"	19.25
A-TM06/PFS06/TM06	3/8"	3/8"	3/8"	21.58
A-TM08/PFS08/TM08	1/2"	1/2"	1/2"	25.22
A-TM12/PFS12/TM12	3/4"	3/4"	3/4"	37.47
A-TM16/PFS16/TM16	1"	1"	1"	56.40
A-TM20/PFS20/TM20	1.1/4"	1.1/4"	1.1/4"	110.12

ADAPTOR - RUN TEE

BSPT Male x BSPP Male x BSPT Male - Run Tee

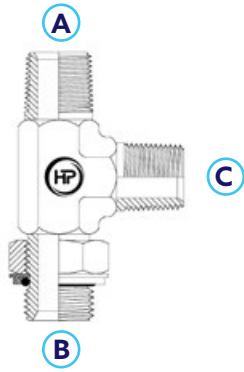

Part Number	A BSPT (M)	B BSPP (M)	C BSPT (M)	List Price (\$)
A-TM04/PM04/TM04	1/4"	1/4"	1/4"	24.68
A-TM06/PM06/TM06	3/8"	3/8"	3/8"	26.40
A-TM08/PM08/TM08	1/2"	1/2"	1/2"	41.00

ADAPTOR - RUN TEE

BSPT Male x BSPT Female Fixed x BSPT Female Fixed - Run Tee

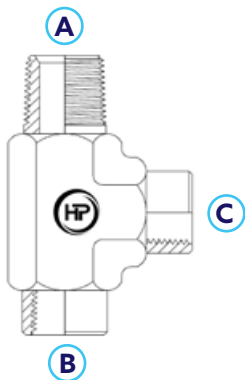

Part Number	A BSPT (M)	B BSPT (F)	C BSPT (F)	List Price (\$)
A-TM02/TF02/TF02	1/8"	1/8"	1/8"	24.43
A-TM04/TF04/TF04	1/4"	1/4"	1/4"	19.90
A-TM06/TF06/TF06	3/8"	3/8"	3/8"	27.70
A-TM08/TF08/TF08	1/2"	1/2"	1/2"	36.03
A-TM12/TF12/TF12	3/4"	3/4"	3/4"	57.90
A-TM16/TF16/TF16	1"	1"	1"	92.43

ADAPTOR - BRANCH TEE

JIC Male x JIC Male x BSPP Male - Branch Tee

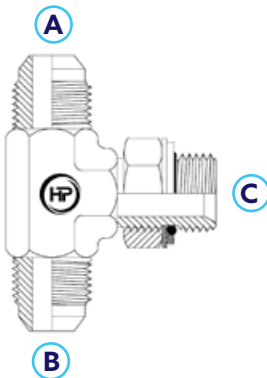

Part Number	A JIC (M)	B JIC (M)	C BSPP (M)	List Price (\$)
A-JM07/JM07/PM04	7/16"	7/16"	1/4"	30.78
A-JM09/JM09/PM04	9/16"	9/16"	1/4"	30.07
A-JM09/JM09/PM06	9/16"	9/16"	3/8"	33.83
A-JM12/JM12/PM06	3/4"	3/4"	3/8"	40.90
A-JM12/JM12/PM08	3/4"	3/4"	1/2"	44.80
A-JM14/JM14/PM08	7/8"	7/8"	1/2"	46.00
A-JM14/JM14/PM12	7/8"	7/8"	3/4"	85.00
A-JM17/JM17/PM12	1.1/16"	1.1/16"	3/4"	59.17
A-JM21/JM21/PM16	1.5/16"	1.5/16"	1"	115.20
A-JM26/JM26/PM20	1.5/8"	1.5/8"	1.1/4"	196.20

ADAPTOR - BRANCH TEE

JIC Male x JIC Male x BSPT Male - Branch Tee

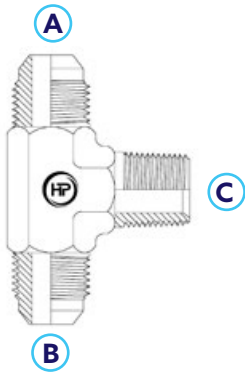

Part Number	A JIC (M)	B JIC (M)	C BSPT (M)	List Price (\$)
A-JM07/JM07/TM02	7/16"	7/16"	1/8"	17.77
A-JM07/JM07/TM04	7/16"	7/16"	1/4"	22.70
A-JM09/JM09/TM04	9/16"	9/16"	1/4"	18.78
A-JM09/JM09/TM06	9/16"	9/16"	3/8"	24.35
A-JM12/JM12/TM06	3/4"	3/4"	3/8"	23.10
A-JM12/JM12/TM08	3/4"	3/4"	1/2"	24.98
A-JM14/JM14/TM08	7/8"	7/8"	1/2"	25.75
A-JM17/JM17/TM12	1.1/16"	1.1/16"	3/4"	38.92
A-JM17/JM17/TM16	1.1/16"	1.1/16"	1"	72.00
A-JM21/JM21/TM16	1.5/16"	1.5/16"	1"	68.33
A-JM26/JM26/TM20	1.5/8"	1.5/8"	1.1/4"	120.00

ADAPTOR - BRANCH TEE

JIC Male x JIC Male x UNO Male - Branch Tee

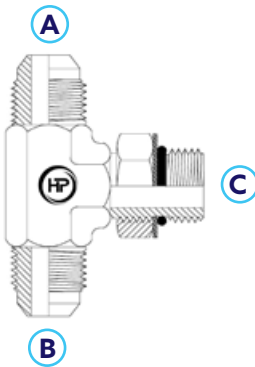

Part Number	A JIC (M)	B JIC (M)	C UNO (M)	List Price (\$)
A-JM07/JM07/UM07	7/16"	7/16"	7/16"	23.77
A-JM09/JM09/UM07	9/16"	9/16"	7/16"	18.97
A-JM09/JM09/UM09	9/16"	9/16"	9/16"	25.22
A-JM09/JM09/UM12	9/16"	9/16"	3/4"	28.10
A-JM12/JM12/UM09	3/4"	3/4"	9/16"	23.24
A-JM12/JM12/UM12	3/4"	3/4"	3/4"	30.12
A-JM12/JM12/UM14	3/4"	3/4"	7/8"	47.18
A-JM14/JM14/UM14	7/8"	7/8"	7/8"	38.47
A-JM17/JM17/UM17	1.1/16"	1.1/16"	1.1/16"	48.82
A-JM21/JM21/UM21	1.5/16"	1.5/16"	1.5/16"	76.67
A-JM26/JM26/UM26	1.5/8"	1.5/8"	1.5/8"	162.03

ADAPTOR - BRANCH TEE

JIC Male x JIC Male x JIC Female Swivel - Branch Tee

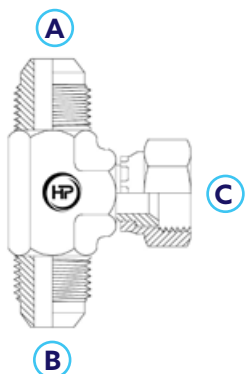

Part Number	A JIC (M)	B JIC (M)	C JIC (FS)	List Price (\$)
A-JM07/JM07/JFS07	7/16"	7/16"	7/16"	21.07
A-JM08/JM08/JFS08	1/2"	1/2"	1/2"	22.27
A-JM09/JM09/JFS09	9/16"	9/16"	9/16"	18.17
A-JM12/JM12/JFS12	3/4"	3/4"	3/4"	23.45
A-JM14/JM14/JFS14	7/8"	7/8"	7/8"	30.25
A-JM17/JM17/JFS17	1.1/16"	1.1/16"	1.1/16"	34.80
A-JM21/JM21/JFS21	1.5/16"	1.5/16"	1.5/16"	50.42
A-JM26/JM26/JFS26	1.5/8"	1.5/8"	1.5/8"	102.48
A-JM30/JM30/JFS30	1.7/8"	1.7/8"	1.7/8"	158.15

ADAPTOR - BRANCH TEE

BSPP Female Swivel x BSPP Female Swivel x BSPT Male - Branch Tee

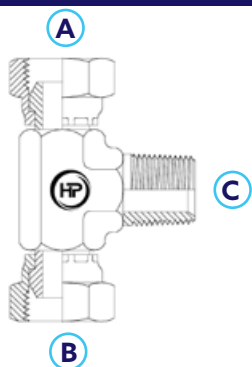

Part Number	A BSPP (FS)	B BSPP (FS)	C BSPT (M)	List Price (\$)
A-PFS04/PFS04/TM04	1/4"	1/4"	1/4"	22.70
A-PFS06/PFS06/TM06	3/8"	3/8"	3/8"	29.20
A-PFS08/PFS08/TM08	1/2"	1/2"	1/2"	34.90
A-PFS12/PFS12/TM12	3/4"	3/4"	3/4"	59.80
A-PFS16/PFS16/TM16	1"	1"	1"	137.40

ADAPTOR - BRANCH TEE

BSPT Male x BSPT Male x BSPP Female Swivel - Branch Tee

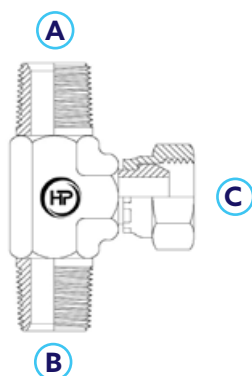

Part Number	A BSPT (M)	B BSPT (M)	C BSPP (FS)	List Price (\$)
A-TM04/TM04/PFS04	1/4"	1/4"	1/4"	30.65
A-TM06/TM06/PFS06	3/8"	3/8"	3/8"	32.55
A-TM08/TM08/PFS08	1/2"	1/2"	1/2"	35.20
A-TM12/TM12/PFS12	3/4"	3/4"	3/4"	45.20
A-TM16/TM16/PFS16	1"	1"	1"	56.75

ADAPTOR - EQUAL TEE

JIC Male x JIC Male x JIC Male - Equal Tee

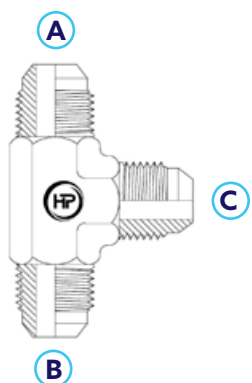

Part Number	A JIC (M)	B JIC (M)	C JIC (M)	List Price (\$)
A-JM07/JM07/JM07	7/16"	7/16"	7/16"	13.82
A-JM08/JM08/JM08	1/2"	1/2"	1/2"	22.18
A-JM09/JM09/JM09	9/16"	9/16"	9/16"	12.63
A-JM09/JM09/JM12	9/16"	9/16"	3/4"	22.95
A-JM12/JM12/JM09	3/4"	3/4"	9/16"	20.00
A-JM12/JM12/JM12	3/4"	3/4"	3/4"	15.47
A-JM12/JM12/JM14	3/4"	3/4"	7/8"	33.08
A-JM12/JM12/JM17	3/4"	3/4"	1.1/16"	62.60
A-JM14/JM14/JM12	7/8"	7/8"	3/4"	22.30
A-JM14/JM14/JM14	7/8"	7/8"	7/8"	26.30
A-JM14/JM14/JM17	7/8"	7/8"	1.1/16"	48.33
A-JM17/JM17/JM14	1.1/16"	1.1/16"	7/8"	51.20
A-JM17/JM17/JM17	1.1/16"	1.1/16"	1.1/16"	27.40
A-JM21/JM21/JM17	1.5/16"	1.5/16"	1.1/16"	51.00
A-JM21/JM21/JM21	1.5/16"	1.5/16"	1.5/16"	45.98
A-JM26/JM26/JM26	1.5/8"	1.5/8"	1.5/8"	92.23
A-JM30/JM30/JM30	1.7/8"	1.7/8"	1.7/8"	141.80
A-JM40/JM40/JM40	2.1/2"	2.1/2"	2.1/2"	276.05

ADAPTOR - EQUAL TEE

BSPP Female x BSPP Female x BSPP Female - Equal Tee

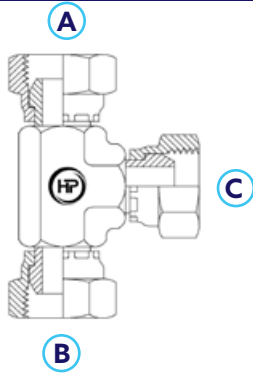

Part Number	A BSPP (F)	B BSPP (F)	C BSPP (F)	List Price (\$)
A-PF04/PF04/PF04	1/4"	1/4"	1/4"	13.40
A-PF06/PF06/PF06	3/8"	3/8"	3/8"	16.00
A-PF08/PF08/PF08	1/2"	1/2"	1/2"	20.00
A-PF12/PF12/PF12	3/4"	3/4"	3/4"	32.00
A-PF16/PF16/PF16	1"	1"	1"	54.00
A-PF32/PF32/PF32	2"	2"	2"	250.00

ADAPTOR - EQUAL TEE

BSPT Male x BSPT Male x BSPT Male - Equal Tee

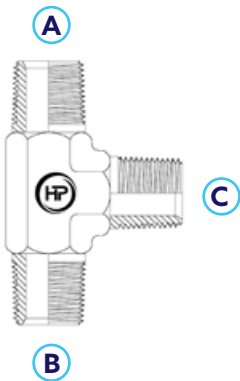

Part Number	A BSPT (M)	B BSPT (M)	C BSPT (M)	List Price (\$)
A-TM02/TM02/TM02	1/8"	1/8"	1/8"	18.48
A-TM04/TM04/TM04	1/4"	1/4"	1/4"	16.82
A-TM06/TM06/TM06	3/8"	3/8"	3/8"	18.32
A-TM08/TM08/TM08	1/2"	1/2"	1/2"	23.77
A-TM08/TM08/TM12	1/2"	1/2"	3/4"	44.90
A-TM12/TM12/TM08	3/4"	3/4"	1/2"	44.95
A-TM12/TM12/TM12	3/4"	3/4"	3/4"	27.95
A-TM16/TM16/TM16	1"	1"	1"	44.07
A-TM20/TM20/TM20	1.1/4"	1.1/4"	1.1/4"	84.78
A-TM24/TM24/TM24	1.1/2"	1.1/2"	1.1/2"	146.35
A-TM32/TM32/TM32	2"	2"	2"	331.80

ADAPTOR - EQUAL TEE

BSPT Female x BSPT Female x BSPT Female - Equal Tee

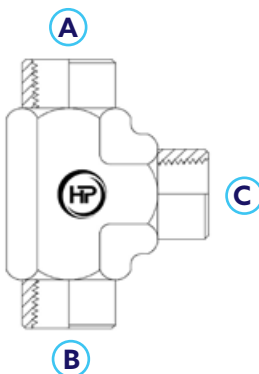

Part Number	A BSPT (F)	B BSPT (F)	C BSPT (F)	List Price (\$)
A-TF02/TF02/TF02	1/8"	1/8"	1/8"	17.35
A-TF04/TF04/TF04	1/4"	1/4"	1/4"	14.78
A-TF06/TF06/TF06	3/8"	3/8"	3/8"	19.05
A-TF08/TF08/TF08	1/2"	1/2"	1/2"	27.43
A-TF12/TF12/TF12	3/4"	3/4"	3/4"	38.50
A-TF16/TF16/TF16	1"	1"	1"	66.65
A-TF20/TF20/TF20	1.1/4"	1.1/4"	1.1/4"	116.12
A-TF24/TF24/TF24	1.1/2"	1.1/2"	1.1/2"	170.07
A-TF32/TF32/TF32	2"	2"	2"	298.98

**JICM X JICM
STRAIGHT BULKHEAD**

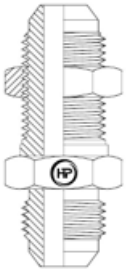

Page 58

**BSPPM X BSPPM
STRAIGHT BULKHEAD**

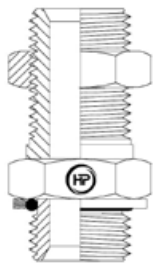

Page 58

**JICM X JICM
90° BULKHEAD**

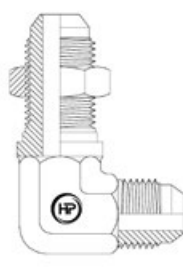

Page 58

**JICM X JICM
45° BULKHEAD**

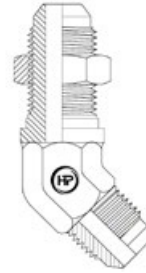

Page 59

**JICF
NUT & SLEEVE**

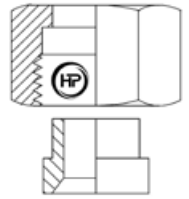

Page 59

**JICM
PLUG**



Page 59

**BSPPM
PLUG**

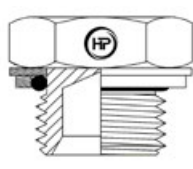

Page 60

**BSPPM
HEX SOCKET PLUG**

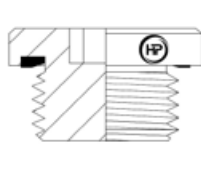

Page 60

**BSPTM
PLUG**

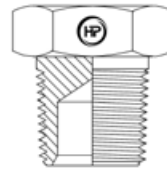

Page 60

**BSPTM
HEX SOCKET PLUG**



Page 61

**UNOM
PLUG**



Page 61

**UNOM
HEX SOCKET PLUG**

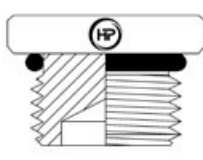

Page 61

**METRICM
PLUG**

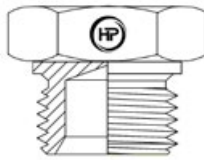

Page 62

For other sizes and thread types please contact us

BULKHEAD - STRAIGHT (M X M)

JIC Male x JIC Male - Straight BulkHead

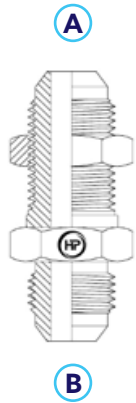

Part Number	A JIC (M)	B JIC (M)	List Price (\$)
BH-JM07/JM07	7/16"	7/16"	11.87
BH-JM09/JM09	9/16"	9/16"	12.05
BH-JM12/JM12	3/4"	3/4"	12.58
BH-JM14/JM14	7/8"	7/8"	14.83
BH-JM17/JM17	1.1/16"	1.1/16"	24.48
BH-JM21/JM21	1.5/16"	1.5/16"	38.52
BH-JM26/JM26	1.5/8"	1.5/8"	56.02
BH-JM30/JM30	1.7/8"	1.7/8"	108.50
BH-JM40/JM40	2.1/2"	2.1/2"	198.25

BULKHEAD - STRAIGHT (M X M)

BSPP Male x BSPP Male - Straight BulkHead

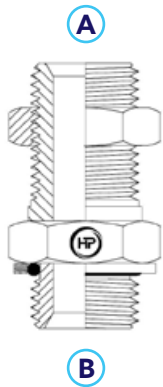

Part Number	A BSPP (M)	B BSPP (M)	List Price (\$)
BH-PM04/PM04	1/4"	1/4"	13.90
BH-PM06/PM06	3/8"	3/8"	19.06
BH-PM08/PM08	1/2"	1/2"	22.34
BH-PM12/PM12	3/4"	3/4"	30.86
BH-PM16/PM16	1"	1"	39.79
BH-PM20/PM20	1.1/4"	1.1/4"	78.87
BH-PM24/PM24	1.1/2"	1.1/2"	137.80

BULKHEAD - 90° ELBOW (M X M)

JIC Male x JIC Male - 90° Elbow BulkHead

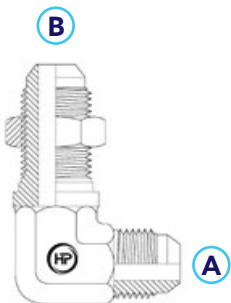

Part Number	A JIC (M)	B JIC (M)	List Price (\$)
BH-JM07/JM07-9	7/16"	7/16"	20.85
BH-JM08/JM08-9	1/2"	1/2"	32.53
BH-JM09/JM09-9	9/16"	9/16"	22.95
BH-JM12/JM12-9	3/4"	3/4"	27.03
BH-JM14/JM14-9	7/8"	7/8"	31.97
BH-JM17/JM17-9	1.1/16"	1.1/16"	42.05
BH-JM21/JM21-9	1.5/16"	1.5/16"	58.03
BH-JM26/JM26-9	1.5/8"	1.5/8"	72.00
BH-JM30/JM30-9	1.7/8"	1.7/8"	128.85

BULKHEAD - 45° ELBOW (M X M)

JIC Male x JIC Male - 45° Elbow BulkHead

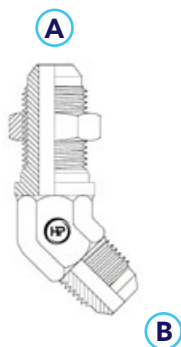

Part Number	A JIC (M)	B JIC (M)	List Price (\$)
BH-JM07/JM07-4	7/16"	7/16"	17.48
BH-JM08/JM08-4	1/2"	1/2"	25.58
BH-JM09/JM09-4	9/16"	9/16"	18.90
BH-JM12/JM12-4	3/4"	3/4"	20.80
BH-JM14/JM14-4	7/8"	7/8"	25.60
BH-JM17/JM17-4	1.1/16"	1.1/16"	34.63
BH-JM21/JM21-4	1.5/16"	1.5/16"	55.43

ADAPTOR - NUT & SLEEVE

JIC Female - Nut & Sleeve

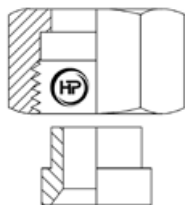

Part Number	JIC (F)	Tube	List Price (\$)
NS-JF07	7/16"	1/4"	5.20
NS-JF08	1/2"	5/16"	6.30
NS-JF09	9/16"	3/8"	5.80
NS-JF12	3/4"	1/2"	7.20
NS-JF14	7/8"	5/8"	9.70
NS-JF17	1.1/16"	3/4"	13.50
NS-JF21	1.5/16"	1"	19.20
NS-JF26	1.5/8"	1.1/4"	34.80
NS-JF30	1.7/8"	1.1/2"	52.30

ADAPTOR - PLUG

JIC Male

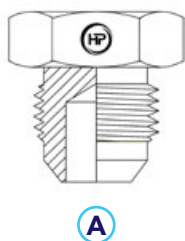

Part Number	A JIC (M)	List Price (\$)
P-JM07	7/16"	3.47
P-JM08	1/2"	4.57
P-JM09	9/16"	4.13
P-JM12	3/4"	3.83
P-JM14	7/8"	4.93
P-JM17	1.1/16"	7.58
P-JM19	1.3/16"	18.10
P-JM21	1.5/16"	19.50
P-JM26	1.5/8"	20.23
P-JM30	1.7/8"	41.17
P-JM40	2.1/2"	109.53

ADAPTOR - PLUG

BSPP Male

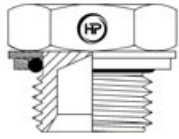

(A)

Part Number	(A) BSPP (M)	List Price (\$)
P-PM02	1/8"	8.50
P-PM04	1/4"	6.40
P-PM06	3/8"	7.08
P-PM08	1/2"	8.79
P-PM12	3/4"	9.77
P-PM16	1"	13.72
P-PM20	1.1/4"	27.37
P-PM24	1.1/2"	37.26
P-PM32	2"	73.72

ADAPTOR - HEX SOCKET PLUG

BSPP Male

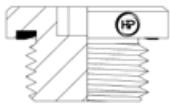

(A)

Part Number	(A) BSPP (M)	List Price (\$)
PH-PM02	1/8"	5.33
PH-PM04	1/4"	6.73
PH-PM06	3/8"	5.60
PH-PM08	1/2"	7.90

ADAPTOR - PLUG

BSPT Male

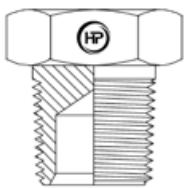

(A)

Part Number	(A) BSPT (M)	List Price (\$)
P-TM02	1/8"	3.83
P-TM04	1/4"	3.48
P-TM06	3/8"	3.18
P-TM08	1/2"	3.63
P-TM12	3/4"	6.35
P-TM16	1"	11.50
P-TM20	1.1/4"	16.33
P-TM24	1.1/2"	23.68
P-TM32	2"	50.47

ADAPTOR - HEX SOCKET PLUG

BSPT Male



A

Part Number	A BSPT (M)	List Price (\$)
PH-TM02	1/8"	5.80
PH-TM04	1/4"	5.00
PH-TM06	3/8"	3.98
PH-TM08	1/2"	5.00
PH-TM12	3/4"	9.87
PH-TM16	1"	14.28

ADAPTOR - PLUG

UNO Male

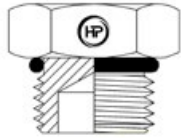

A

Part Number	A UNO (M)	List Price (\$)
P-UM06	3/8"	4.23
P-UM07	7/16"	4.43
P-UM08	1/2"	5.53
P-UM09	9/16"	4.20
P-UM12	3/4"	4.40
P-UM14	7/8"	5.33
P-UM17	1.1/16"	7.68
P-UM19	1.3/16"	23.75
P-UM21	1.5/16"	18.63
P-UM26	1.5/8"	19.30
P-UM30	1.7/8"	41.05
P-UM40	2.1/2"	69.25

ADAPTOR - HEX SOCKET PLUG

UNO Male

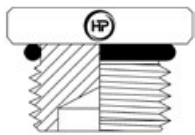

A

Part Number	A UNO (M)	List Price (\$)
PH-UM05	5/16"	4.30
PH-UM06	3/8"	3.26
PH-UM07	7/16"	4.28
PH-UM08	1/2"	3.90
PH-UM09	9/16"	3.97
PH-UM12	3/4"	4.32
PH-UM14	7/8"	5.13
PH-UM17	1.1/16"	6.97
PH-UM21	1.5/16"	11.48
PH-UM26	1.5/8"	16.22
PH-UM30	1.7/8"	26.86
PH-UM40	2.1/2"	39.95

ADAPTOR - PLUG

METRIC Male



A

Part Number	A METRIC (M)	List Price (\$)
P-MM10	M10 x 1.5	8.00
P-MM12	M12 x 1.5	6.50
P-MM14	M14 x 1.5	7.05
P-MM15	M15 x 1.5	9.10
P-MM16	M16 x 1.5	7.30
P-MM18	M18 x 1.5	8.55
P-MM20	M20 x 1.5	8.55
P-MM22	M22 x 1.5	8.35
P-MM24	M24 x 1.5	13.95
P-MM26	M26 x 1.5	18.90
P-MM27	M27 x 1.5	22.50
P-MM28	M28 x 1.5	20.00
P-MM30	M30 x 2.0	26.12
P-MM33	M33 x 2.0	25.36
P-MM36	M36 x 2.0	38.95
P-MM42	M42 x 2.0	51.00
P-MM52	M52 x 2.0	67.25

ACCESSORIES

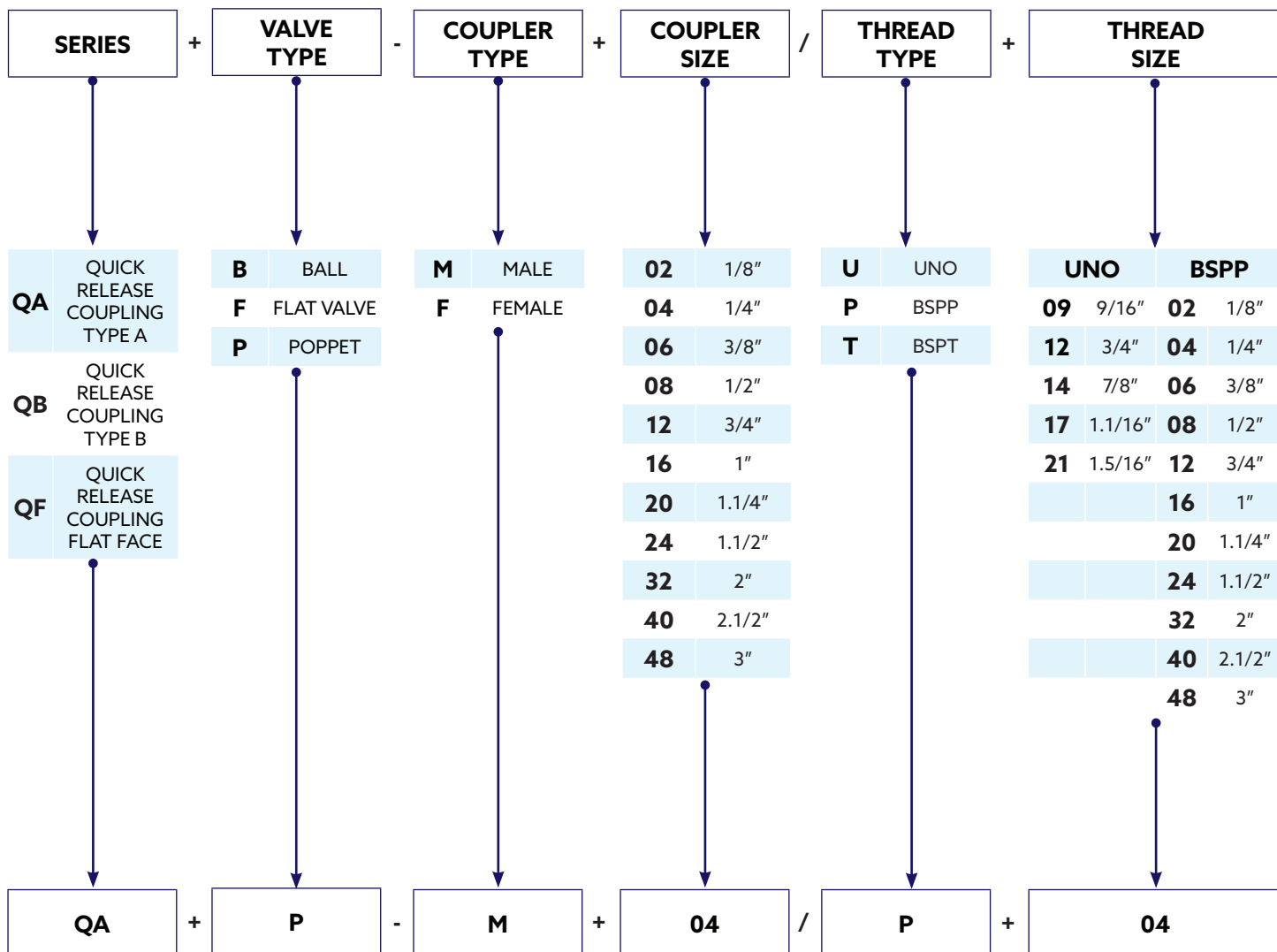

Example
QAP-M04/P04
 Quick Release Coupler Type A Poppet Valve
 1/4" BSPP Male Tip

CODING SYSTEM

Tube Clamps, Stacking Bolts & Stacking Plates

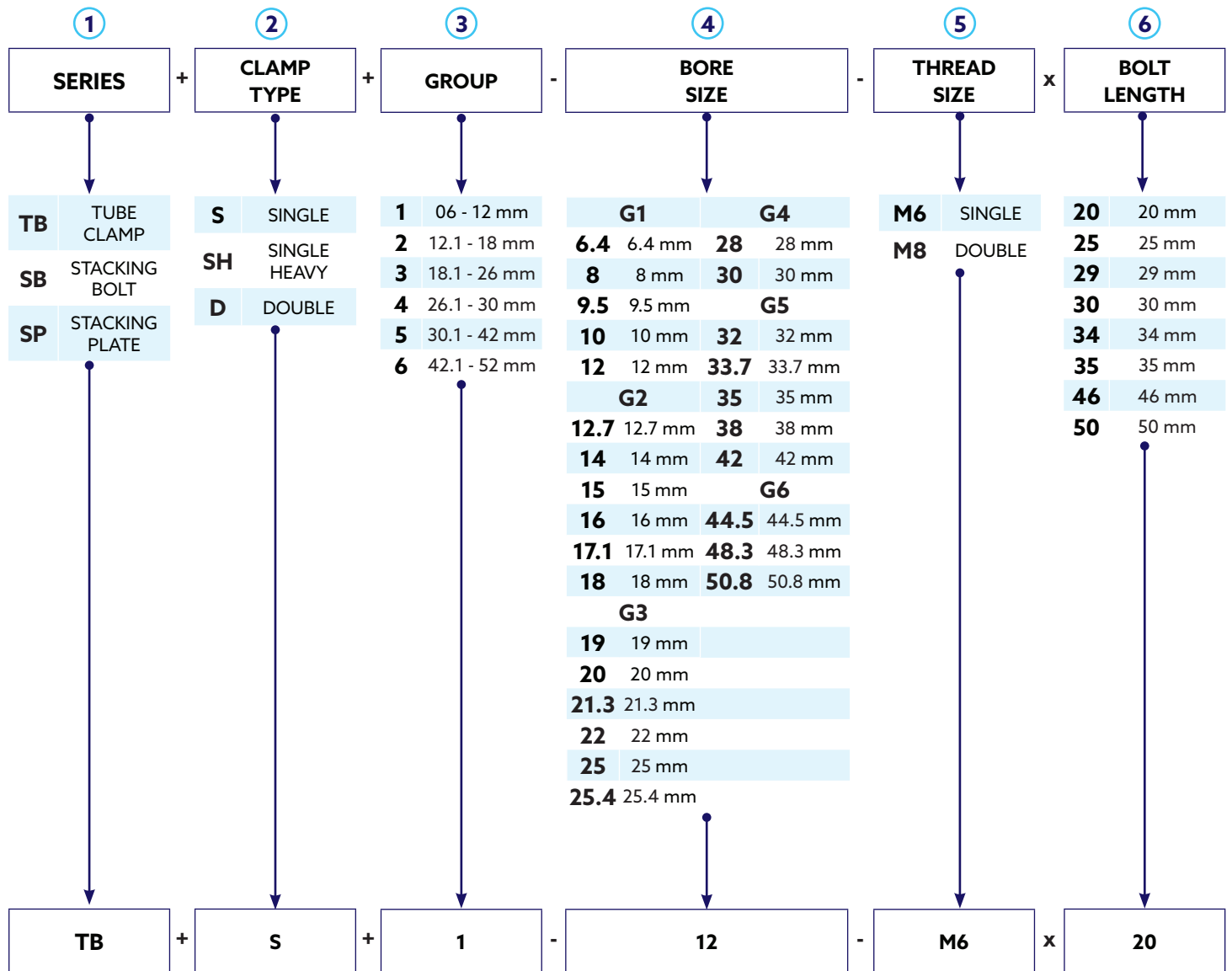

For **TUBE CLAMPS** use 1-4 above

Example (Tube Clamp)
TBS1-12
 Tube Clamp Single, Group 1
 12 mm Bore Size

For **STACKING BOLTS** use 1-3, 5-6 above

Example (Stacking Bolt)
SBS1-M6x20
 Stacking Bolt Single Group 1,
 Metric 6 - 20 mm long

For **STACKING PLATES** use 1-3 above

Example (Stacking Plate)
SPS1
 Stacking Plate Single Group 1

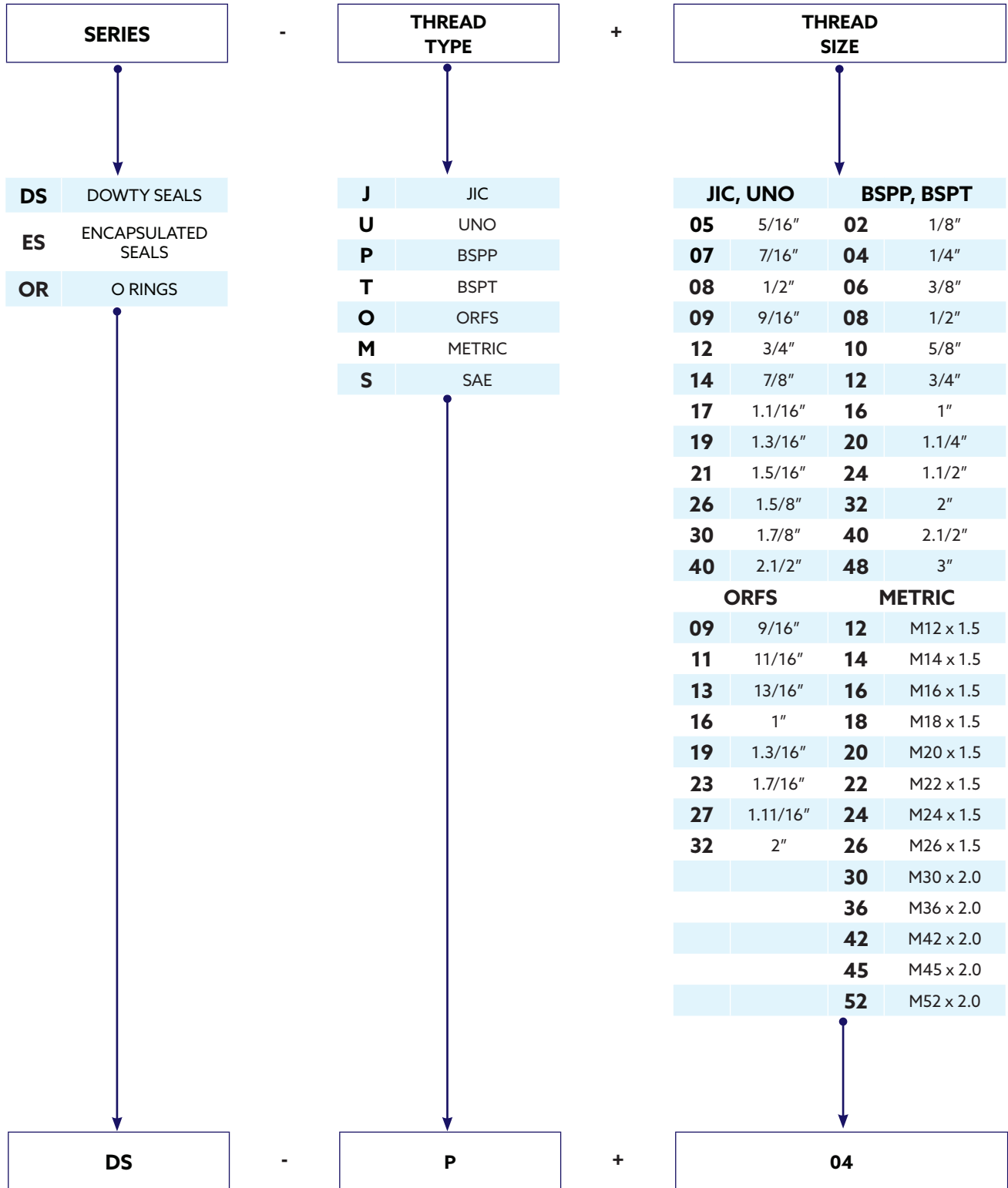

Example
DS-P04
 BSPP 1/4" Dowty Seal

**QUICK RELEASE
COUPLER-TYPE A**

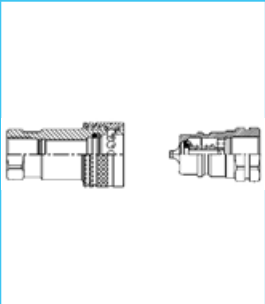

Page 68

**QUICK RELEASE
COUPLER-FLAT FACE**

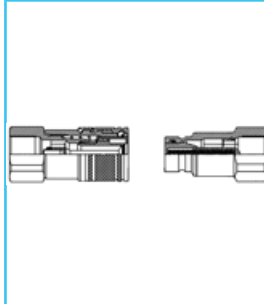

Page 69

**TUBE CLAMP
SINGLE**

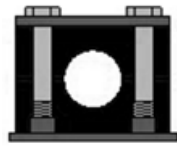

Page 70

**TUBE CLAMP
SINGLE HEAVY**

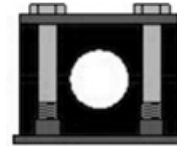

Page 70

**TUBE CLAMP
DOUBLE**

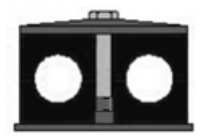

Page 71

**STACKING BOLT
SINGLE**



Page 71

**STACKING BOLT
DOUBLE**



Page 71

**STACKING PLATE
SINGLE**



Page 72

**STACKING PLATE
DOUBLE**



Page 72

**DOWTY SEAL
METRIC**



Page 72

**DOWTY SEAL
BSPP**



Page 73

**ENCAPSULATED SEAL
BSPP**



Page 73

**O' RING
BSPP**



Page 73

**O' RING
ORFS**



Page 74

**O' RING
UNO**



Page 74

**O' RING
SAE**



Page 74

For other sizes and thread types please contact us

QUICK RELEASE COUPLING - TYPE A

Poppet Valve - Male Tip & Coupler

Series: ISO 7241-1 Type A

Valve type: Poppet

Material: Steel

Interchanges with: Faster ANV, Parker 6600, DNP PAV, Aeroquip FD56, Safeway S56, Ryco R82

Applications: Conforming to ISO 7421-1 Type A used in the Marine and other applications requiring high corrosion resistance.

Features: Single acting pull to release sleeve, Poppet type valve for improved sealing.

Technical: Seals - Nitrile (Buna N), PTFE backup ring.

Temperature Range: 25°C to +125°C.

Options: NPT and UNO Threads to Order, Plastic Caps and Plugs, Push-Pull Coupler in 1/2"

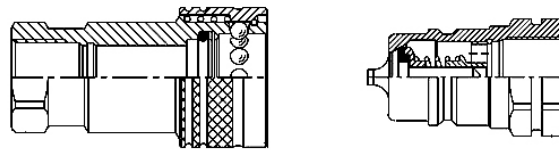

Part Number (Male Tip)	Thread Size	BSPP (F)	WP Bar	List Price (\$)
QAP-M04/P04	1/4"	1/4"	350	15.48
QAP-M06/P06	3/8"	3/8"	300	15.38
QAP-M08/P08	1/2"	1/2"	250	17.65
QAP-M12/P12	3/4"	3/4"	250	35.68
QAP-M16/P16	1"	1"	230	73.63
QAP-M20/P20	1.1/4"	1.1/4"	230	166.50
QAP-M24/P24	1.1/2"	1.1/2"	180	124.25
QAP-M32/P32	2"	2"	130	279.50

Part Number (Coupler)	Thread Size	BSPP (F)	WP Bar	List Price (\$)
QAP-F04/P04	1/4"	1/4"	350	35.08
QAP-F06/P06	3/8"	3/8"	300	34.90
QAP-F08/P08	1/2"	1/2"	250	37.55
QAP-F12/P12	3/4"	3/4"	250	81.70
QAP-F16/P16	1"	1"	230	127.40
QAP-F20/P20	1.1/4"	1.1/4"	230	311.85
QAP-F24/P24	1.1/2"	1.1/2"	180	460.25
QAP-F32/P32	2"	2"	130	849.40

QUICK RELEASE COUPLING - FLAT FACE

Flat Valve - Male Tip & Coupler

Series: Flat Face

Valve type: Flat valve

Material: Steel

Interchanges with: Faster FFI,Parker FE,DNP PLT4,Safeway S56,Ryco R110.

Applications: Conforming to ISO 7421-1 Type B used in general purpose hydraulic applications.

Features: Widely used in the public utility markets where oil spillage can constitute a serious hazard.Ease of cleaning is a special feature making these couplers particularly suitable for hostile environments.

Technical: Seals - Nitrile (Buna N), PTFE backup ring.

Temperature Range: 25°C to +125°C

Options: Neoprene,EPDM and Viton seals available. (Available in Stainless Steel).

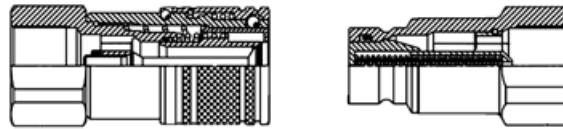

Part Number (Male Tip)	Thread Size	BSPF (F)	WP Bar	List Price (\$)
QFF-M04/P04	1/4"	1/4"	350	70.90
QFF-M06/P06	3/8"	3/8"	250	50.05
QFF-M08/P06	1/2"	3/8"	250	55.25
QFF-M08/P08	1/2"	1/2"	250	83.75
QFF-M12/P08	3/4"	1/2"	250	100.05
QFF-M12/P12	3/4"	3/4"	250	140.20
QFF-M16/P12	1"	3/4"	250	140.20
QFF-M16/P16	1"	1"	210	296.20

Part Number (Coupler)	Thread Size	BSPF (F)	WP Bar	List Price (\$)
QFF-F04/P04	1/4"	1/4"	300	71.83
QFF-F06/P06	3/8"	3/8"	250	84.28
QFF-F08/P06	1/2"	3/8"	250	89.25
QFF-F08/P08	1/2"	1/2"	250	109.63
QFF-F12/P08	3/4"	1/2"	250	116.03
QFF-F12/P12	3/4"	3/4"	250	224.85
QFF-F16/P12	1"	3/4"	250	238.10
QFF-F16/P16	1"	1"	210	441.55

TUBE CLAMP

Single

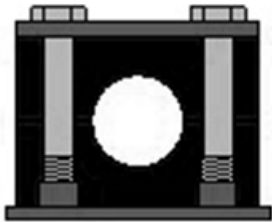

Part Number	Group	Bore Size	List Price (\$)
TCS1-6.4	1	6.4 mm	4.90
TCS1-8	1	8 mm	7.40
TCS1-9.5	1	9.5 mm	4.97
TCS1-10	1	10 mm	5.10
TCS1-12	1	12 mm	5.07
TCS2-12.7	2	12.7 mm	4.70
TCS2-14	2	14 mm	5.23
TCS2-15	2	15 mm	5.57
TCS2-16	2	16 mm	5.23
TCS2-17.1	2	17.1 mm	4.50
TCS2-18	2	18 mm	5.23
TCS3-19	3	19 mm	5.87
TCS3-20	3	20 mm	5.80
TCS3-21.3	3	21.3 mm	5.20
TCS3-22	3	22 mm	6.13
TCS3-25	3	25 mm	5.05
TCS3-25.4	3	25.4 mm	5.75
TCS4-28	4	28 mm	6.43
TCS4-30	4	30 mm	6.43
TCS5-32	5	32 mm	8.03
TCS5-33.7	5	33.7 mm	8.70
TCS5-35	5	35 mm	8.12
TCS5-38	5	38 mm	8.40
TCS5-42	5	42 mm	8.11
TCS6-50.8	6	50.8 mm	12.20

TUBE CLAMP

Single Heavy

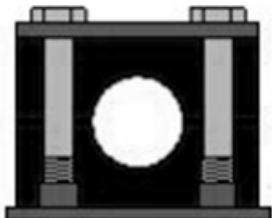

Part Number	Group	Bore Size	List Price (\$)
TCSH2-15	2	15	8.30
TCSH2-16	2	16	10.65
TCSH2-18	2	18	8.30
TCSH3-19	3	19	13.33
TCSH3-20	3	20	10.40
TCSH3-22	3	22	10.40
TCSH4-28	4	28	10.40
TCSH4-30	4	30	10.40
TCSH5-32	5	32	17.94
TCSH5-38	5	38	17.94
TCSH5-42	5	42	17.19
TCSH6-44.5	6	44.5	51.32
TCSH6-48.3	6	48.3	51.32
TCSH6-50.8	6	50.8	39.77

TUBE CLAMP

Double

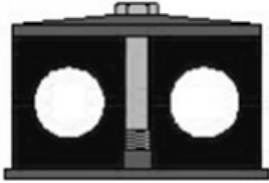

Part Number	Group	Bore Size	List Price (\$)
TCD1-6.4	1	6.4	5.45
TCD1-8	1	8	5.70
TCD1-9.5	1	9.5	5.37
TCD1-10	1	10	5.60
TCD1-12	1	12	5.60
TCD2-12.7	2	12.7	6.02
TCD2-14	2	14	6.50
TCD2-15	2	15	6.50
TCD2-16	2	16	6.50
TCD2-17.1	2	17.1	6.20
TCD2-18	2	18	6.50
TCD3-19	3	19	7.23
TCD3-20	3	20	7.33
TCD3-21.3	3	21.3	7.30
TCD3-22	3	22	7.33
TCD3-25	3	25	6.28
TCD3-25.4	3	25.4	7.26
TCD4-28	4	28	8.50
TCD4-30	4	30	8.50
TCD5-32	5	32	10.48
TCD5-33.7	5	33.7	10.55
TCD5-35	5	35	9.80
TCD5-38	5	38	10.82
TCD5-42	5	42	11.43

STACKING BOLT

Single



Part Number	Group	Bolt Size	List Price (\$)
SBS1-M6x20	1	20 mm	2.40
SBS2-M6x25	2	25 mm	2.92
SBS3-M6x30	3	30 mm	3.35
SBS4-M6x35	4	35 mm	3.43
SBS5-M6x50	5	50 mm	3.73

STACKING BOLT

Double



Part Number	Group	Bolt Size	List Price (\$)
SBD1-M6x20	1	20 mm	2.98
SBD2-M8x20	2	20 mm	3.32
SBD3-M8x29	3	29 mm	3.49
SBD4-M8x34	4	34 mm	4.00
SBD5-M8x46	5	46 mm	3.91

STACKING PLATE

Single



Part Number	Group	List Price (\$)
SPS1	1	0.30
SPS2	2	0.95
SPS3	3	1.10
SPS4	4	1.28
SPS5	5	1.50

STACKING PLATE

Double



Part Number	Group	List Price (\$)
SPD1	1	0.95
SPD2	2	1.1

SEAL - DOWTY

Metric



Part Number	Size	List Price (\$)
DS-M08	8 mm	2.90
DS-M10	10 mm	1.95
DS-M12	12 mm	1.68
DS-M14	14 mm	1.85
DS-M16	16 mm	1.94
DS-M18	18 mm	2.36
DS-M20	20 mm	2.03
DS-M22	22 mm	2.31
DS-M24	24 mm	2.44
DS-M26	26 mm	2.83
DS-M27	27 mm	3.29
DS-M30	30 mm	3.75
DS-M33	33 mm	4.73
DS-M36	36 mm	5.10
DS-M42	42 mm	7.67
DS-M45	45 mm	7.50
DS-M48	48 mm	10.56
DS-M52	52 mm	9.00

SEAL - DOWTY

BSPB



Part Number	Size (BSPB)	List Price (\$)
DS-P02	1/8"	1.56
DS-P04	1/4"	1.74
DS-P06	3/8"	1.86
DS-P08	1/2"	2.03
DS-P10	5/8"	1.73
DS-P12	3/4"	2.59
DS-P16	1"	3.50
DS-P20	1.1/4"	6.20
DS-P24	1.1/2"	7.37
DS-P32	2"	11.41
DS-P40	2.1/2"	60.88

SEAL - ENCAPSULATED

BSPB

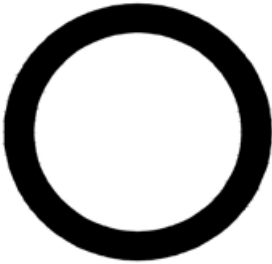

Part Number	Size	List Price (\$)
ES-P04	1/4"	0.65
ES-P06	3/8"	0.63
ES-P08	1/2"	0.74
ES-P12	3/4"	0.81
ES-P16	1"	1.35
ES-P20	1.1/4"	2.00

RING - O'

BSPB



Part Number	Size	List Price (\$)
OR-P02	1/8"	1.23
OR-P04	1/4"	1.37
OR-P06	3/8"	1.42
OR-P08	1/2"	1.27
OR-P10	5/8"	1.32
OR-P12	3/4"	1.42
OR-P16	1"	1.57
OR-P20	1.1/4"	2.19
OR-P24	1.1/2"	3.77
OR-P32	2"	7.23

RING - O'

ORFS



Part Number	Size	List Price (\$)
OR-O09	9/16"	0.68
OR-O11	11/16"	0.72
OR-O13	13/16"	0.89
OR-O16	1"	1.04
OR-O19	1.3/16"	1.35
OR-O23	1.7/16"	1.58
OR-O27	1.11/16"	2.05
OR-O32	2"	2.50

RING - O'

UNO



Part Number	Size	List Price (\$)
OR-U07	7/16"	0.89
OR-U08	1/2"	0.92
OR-U09	9/16"	0.92
OR-U12	3/4"	1.25
OR-U14	7/8"	1.25
OR-U17	1.1/16"	1.25
OR-U21	1.5/16"	1.55
OR-U26	1.5/8"	2.25
OR-U30	1.7/8"	2.55
OR-U40	2.1/2"	3.78

RING - O'

SAE



Part Number	Size	List Price (\$)
OR-S08	1/2"	1.41
OR-S12	3/4"	1.58
OR-S14	7/8"	2.20
OR-S16	1"	2.05
OR-S20	1.1/4"	2.25
OR-S24	1.1/2"	2.96
OR-S32	2"	3.52
OR-S40	2.1/2"	4.62

FULL RANGE

PICTURE INDEX - HOSE ENDS FULL RANGE

Crimp Fittings - One Piece & Two Piece

JIC FEMALE SWIVEL
STRAIGHT

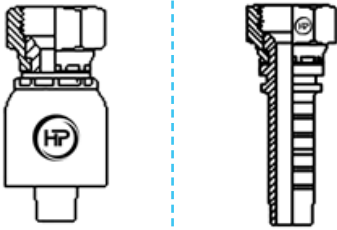

Page 14

JIC MALE STRAIGHT

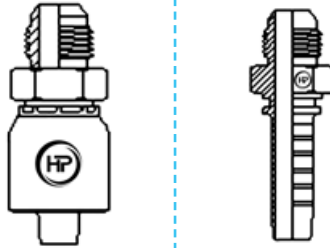

Page 16

JIC FEMALE SWIVEL
90° COMPACT

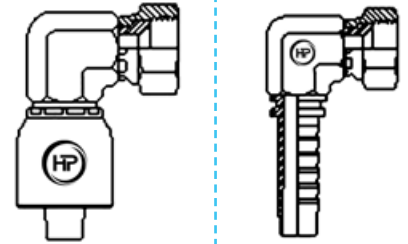

Page 14

JIC FEMALE SWIVEL
90° SWEPT

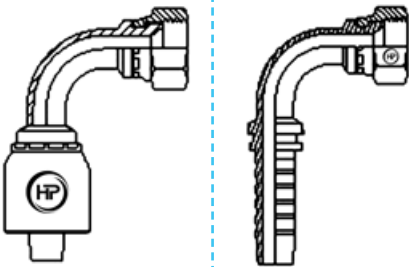

Page 15

JIC FEMALE SWIVEL
90° LONG DROP

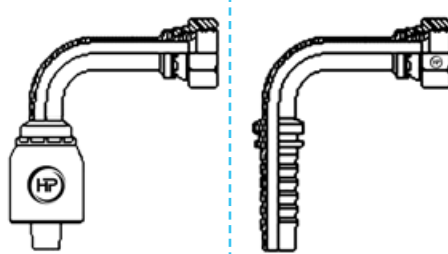

Page 15

JIC FEMALE SWIVEL
45° SWEPT

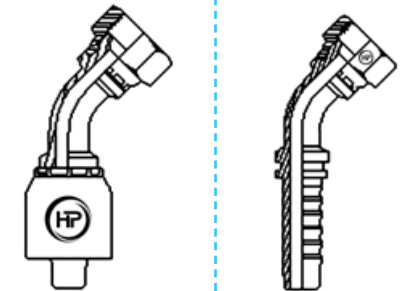

Page 16

BSPF FEMALE SWIVEL
STRAIGHT

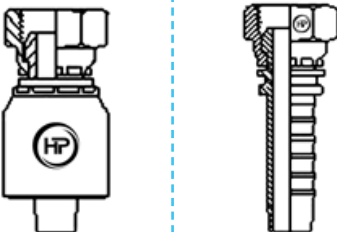

Page 18

BSPF MALE STRAIGHT

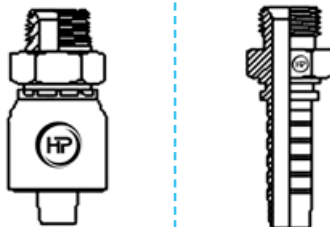

Page 18

BSPT MALE STRAIGHT

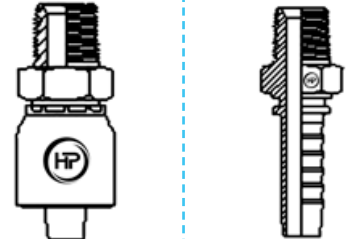

Page 19

BSPF FEMALE SWIVEL
90° COMPACT

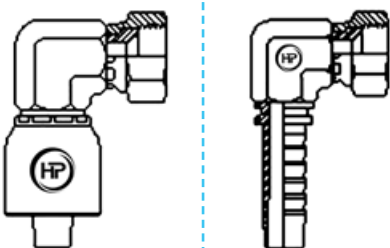

Page 19

BSPF FEMALE SWIVEL
90° SWEPT

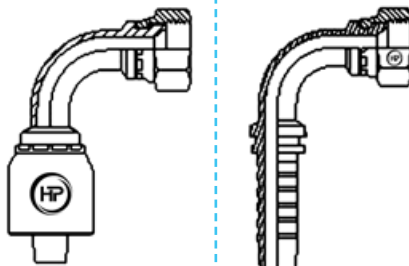

Page 20

BSPF FEMALE SWIVEL
45° SWEPT

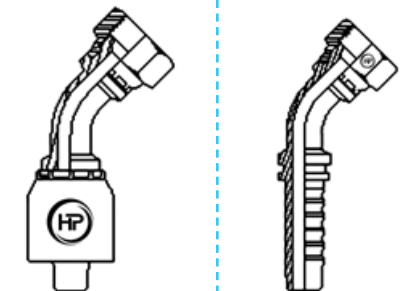

Page 20

For POA please contact us

Continued on the following page...

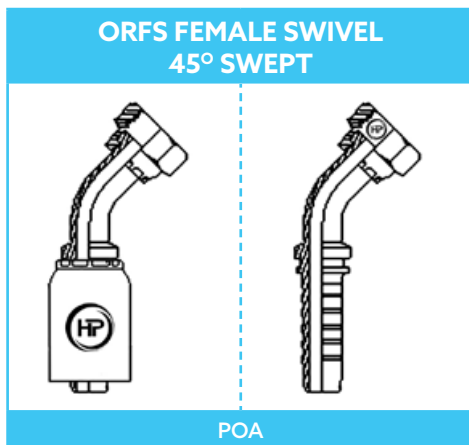
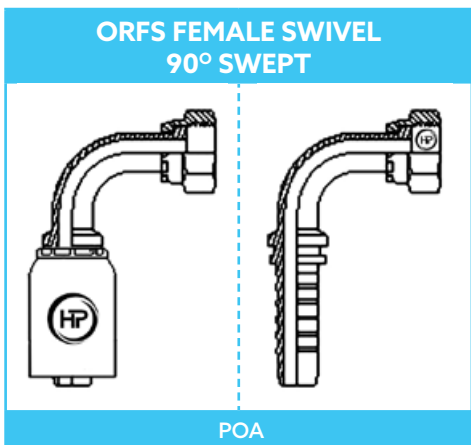
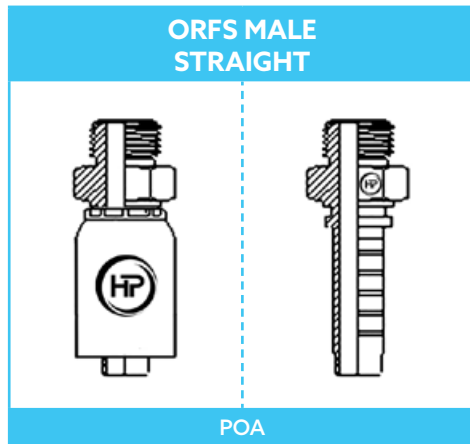
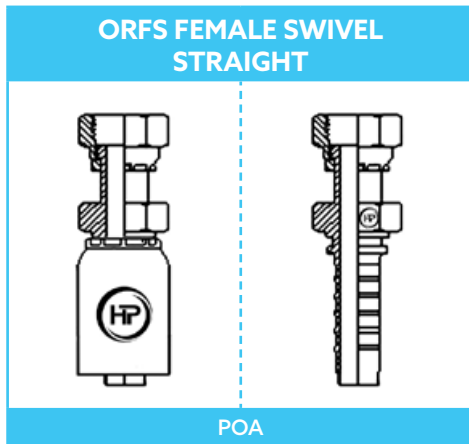
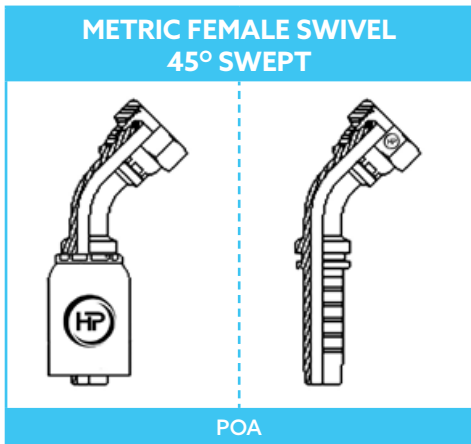
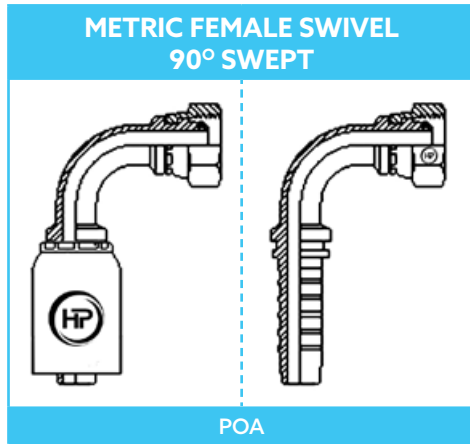
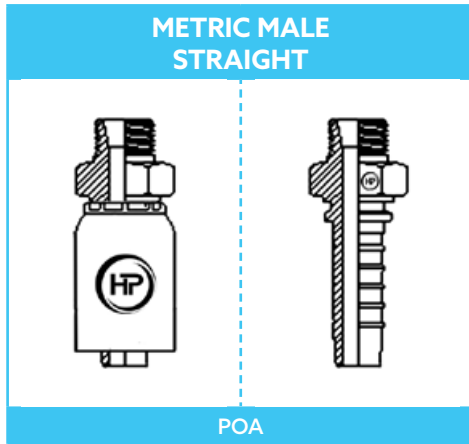
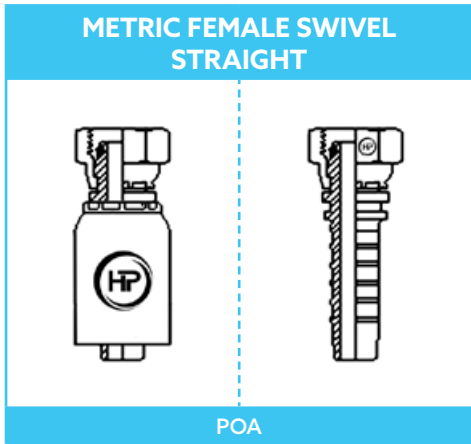
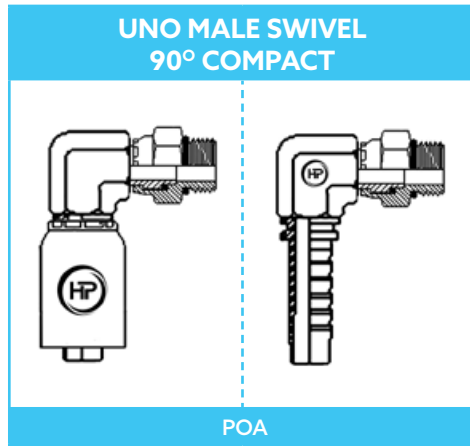
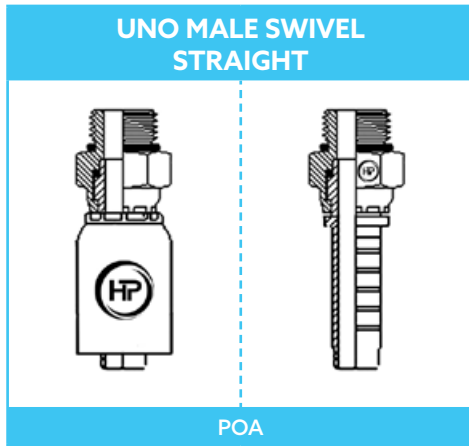
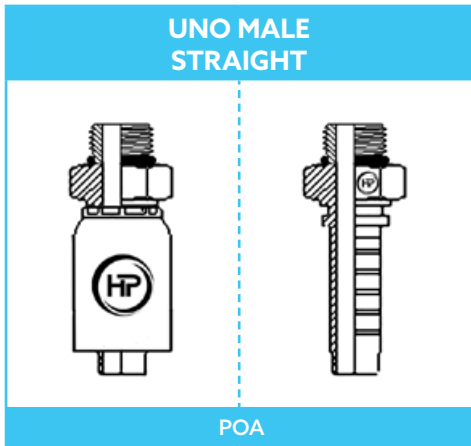

For POA please contact us

Continued on the following page...

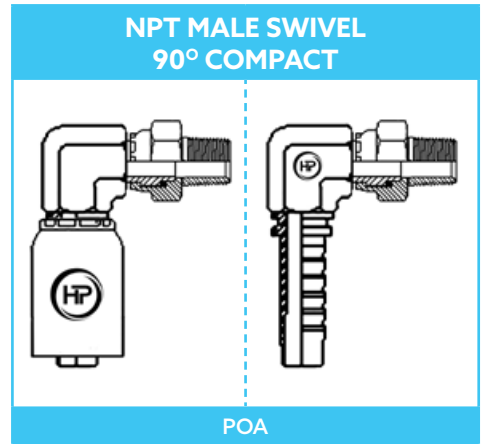
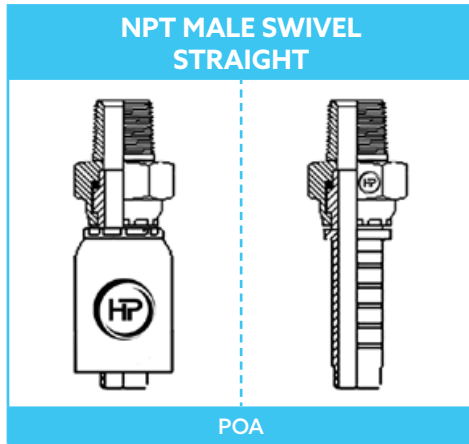
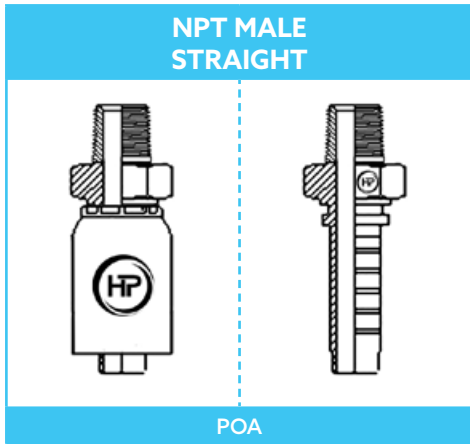
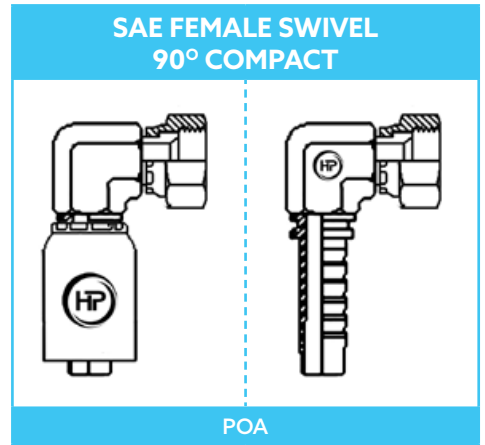
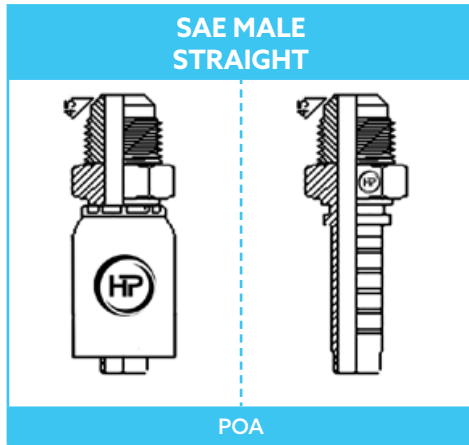
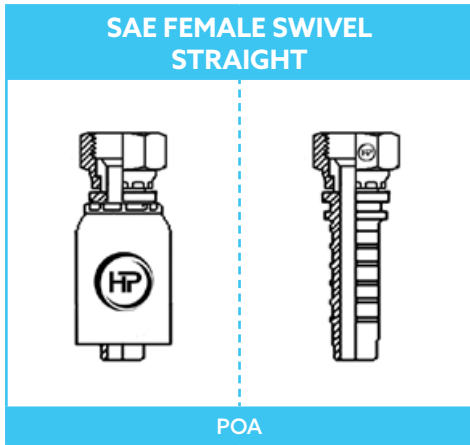

Suction Fittings

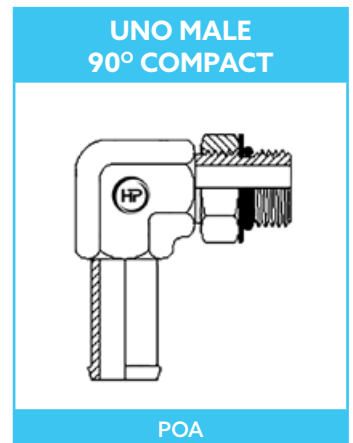
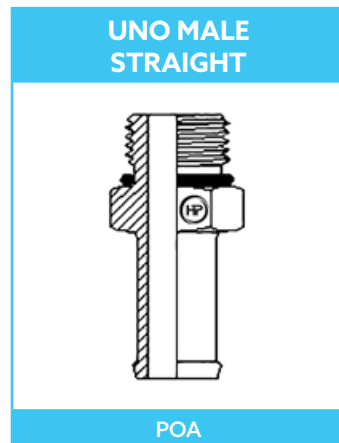
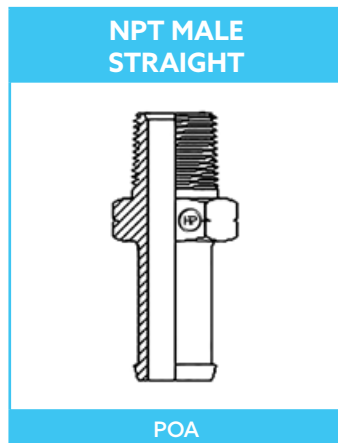
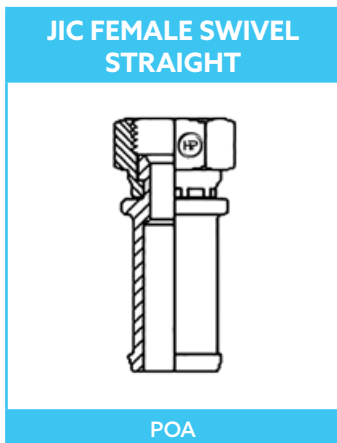
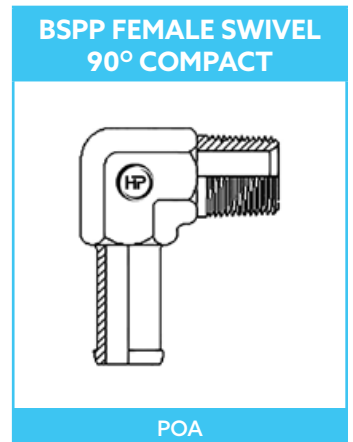
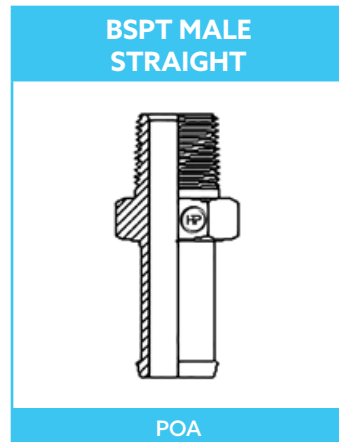
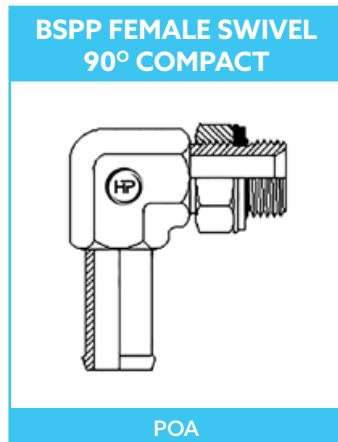
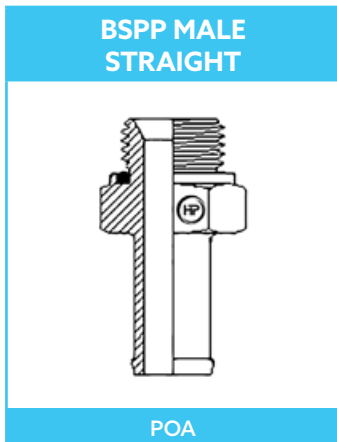

For POA please contact us

Reusable Fittings

BSPP FEMALE SWIVEL STRAIGHT

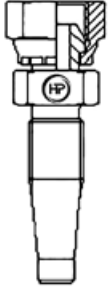

POA

BSPT MALE STRAIGHT

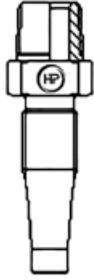

POA

BSPP MALE 90° COMPACT

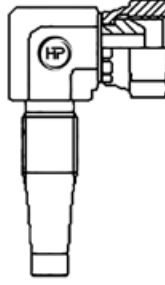

POA

BSPP FEMALE SWIVEL 90° SWEPT

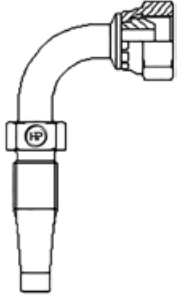

POA

BSPP FEMALE SWIVEL 45° SWEPT

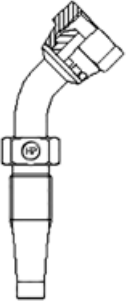

POA

JIC FEMALE SWIVEL STRAIGHT

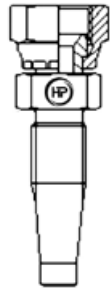

POA

JIC MALE STRAIGHT

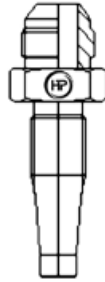

POA

JIC FEMALE SWIVEL 90° COMPACT

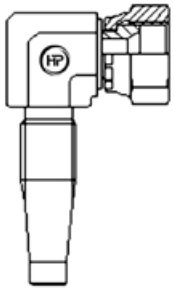

POA

JIC FEMALE SWIVEL 90° SWEPT

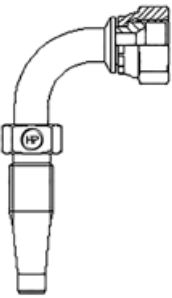

POA

JIC FEMALE SWIVEL 45° SWEPT

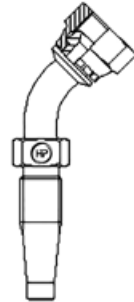

POA

ORFS FEMALE SWIVEL STRAIGHT

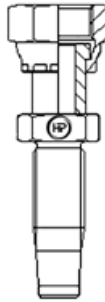

POA

ORFS FEMALE SWIVEL 90° SWEPT

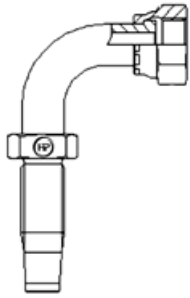

POA

ONE WIRE FERRULE



POA

TWO WIRE FERRULE







POA

For POA please contact us

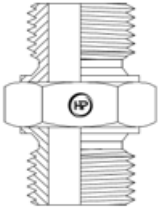
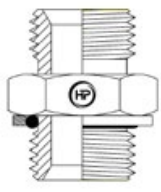
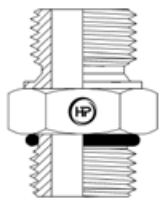
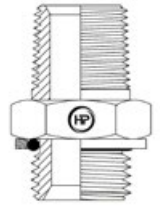
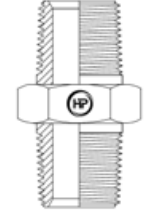
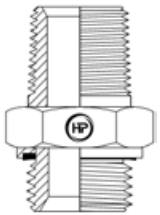
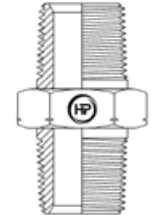
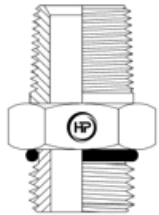

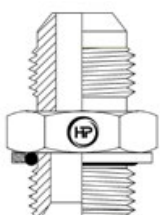
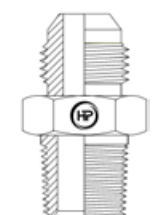
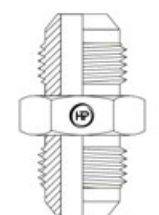
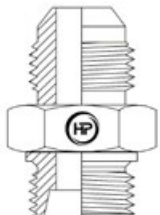
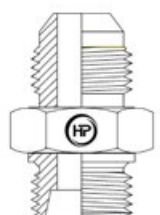
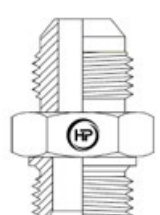
PICTURE INDEX - ADAPTORS FULL RANGE

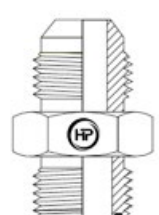
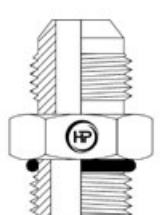
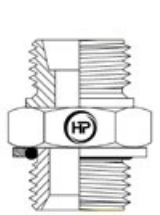
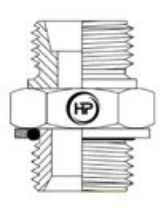
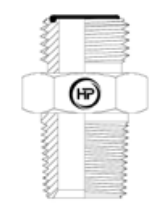
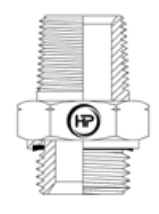
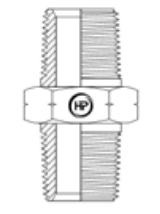
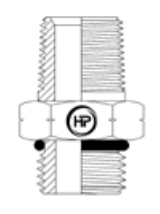
Straight M x M, M x F & F x F

<p>BSPPM X BSPPM (DS) STRAIGHT (M X M)</p>  <p>Page 27</p>	<p>BSPPM X BSPPM STRAIGHT (M X M)</p>  <p>POA</p>	<p>BSPPM X UNOM STRAIGHT (M X M)</p>  <p>POA</p>	<p>BSPTM X BSPPM STRAIGHT (M X M)</p>  <p>Page 28</p>	<p>BSPTM X BSPTM STRAIGHT (M X M)</p>  <p>Page 28</p>
<p>BSPTM X METRICM STRAIGHT (M X M)</p>  <p>POA</p>	<p>BSPTM X NPTM STRAIGHT (M X M)</p>  <p>POA</p>	<p>BSPTM X UNOM STRAIGHT (M X M)</p>  <p>Page 29</p>	<p>JICM BANJO STRAIGHT (M X M)</p>  <p>POA</p>	<p>JICM EXT X UNOM STRAIGHT (M X M)</p>  <p>POA</p>
<p>JICM X BSPPM STRAIGHT (M X M)</p>  <p>Page 24</p>	<p>JICM X BSPTM STRAIGHT (M X M)</p>  <p>Page 25</p>	<p>JICM X JICM STRAIGHT (M X M)</p>  <p>Page 27</p>	<p>JICM X METRICM(DKL) STRAIGHT (M X M)</p>  <p>POA</p>	<p>JICM X METRICM(DKS) STRAIGHT (M X M)</p>  <p>POA</p>
<p>JICM X METRICM STRAIGHT (M X M)</p>  <p>POA</p>	<p>JICM X NPTM STRAIGHT (M X M)</p>  <p>POA</p>	<p>JICM X ORFSM STRAIGHT (M X M)</p>  <p>POA</p>	<p>JICM X UNOM STRAIGHT (M X M)</p>  <p>Page 26</p>	<p>METRICM(DKL) X BSPTM STRAIGHT (M X M)</p>  <p>POA</p>
<p>METRICM(DKS) X BSPTM STRAIGHT (M X M)</p>  <p>POA</p>	<p>METRICM(FF) X BSPTM STRAIGHT (M X M)</p>  <p>POA</p>	<p>NPTM X BSPPM STRAIGHT (M X M)</p>  <p>POA</p>	<p>NPTM X NPTM STRAIGHT (M X M)</p>  <p>POA</p>	<p>NPTM X UNOM STRAIGHT (M X M)</p>  <p>POA</p>

For POA please contact us

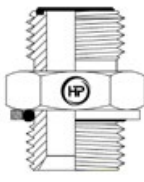
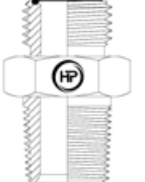
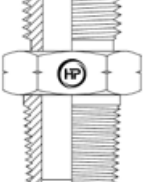
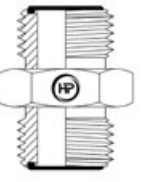
Continued on the following page...

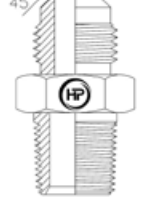
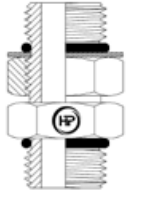
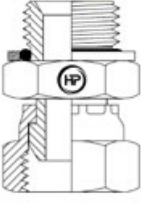
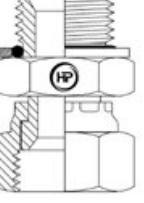
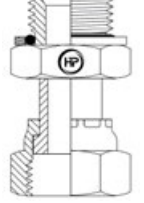
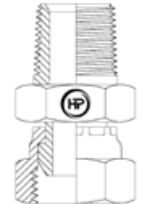
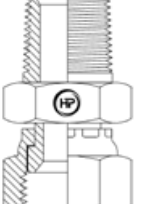
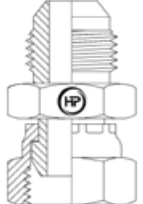
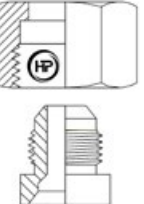
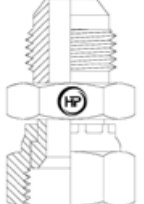
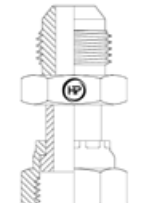
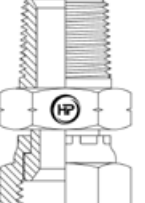
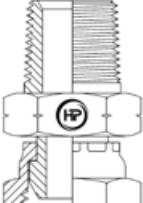
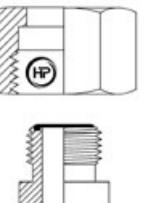
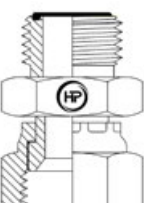
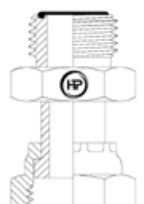
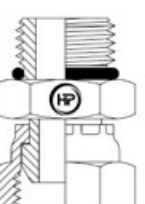
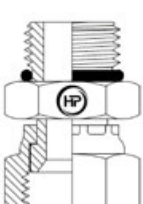
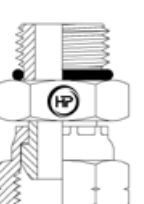
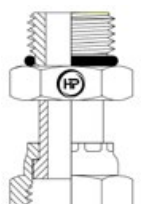
<p>ORFSM X BSPPM STRAIGHT (M X M)</p>  <p>POA</p>	<p>ORFSM X BSPTM STRAIGHT (M X M)</p>  <p>POA</p>	<p>ORFSM X NPTM STRAIGHT (M X M)</p>  <p>POA</p>	<p>ORFSM X ORFSM STRAIGHT (M X M)</p>  <p>POA</p>	<p>ORFSM X UNOM STRAIGHT (M X M)</p>  <p>POA</p>
<p>SAEM(45°) X BSPTM STRAIGHT (M X M)</p>  <p>POA</p>	<p>UNOM X UNOM STRAIGHT (M X M)</p>  <p>POA</p>	<p>BSPPM X BSPPF STRAIGHT (M X FS)</p>  <p>Page 32</p>	<p>BSPPM X JICF STRAIGHT (M X FS)</p>  <p>Page 30</p>	<p>BSPPM X ORFSF STRAIGHT (M X FS)</p>  <p>POA</p>
<p>BSPTM X BSPPF STRAIGHT (M X FS)</p>  <p>Page 32</p>	<p>BSPTM X JICF STRAIGHT (M X FS)</p>  <p>Page 30</p>	<p>JICM X BSPPF STRAIGHT (M X FS)</p>  <p>POA</p>	<p>JICM X JICF (TR) STRAIGHT (M X FS)</p>  <p>Page 31</p>	<p>JICM X JICF STRAIGHT (M X FS)</p>  <p>Page 31</p>
<p>JICM X ORFSF STRAIGHT (M X FS)</p>  <p>POA</p>	<p>NPTM X JICF STRAIGHT (M X FS)</p>  <p>POA</p>	<p>NPTM X NPTF STRAIGHT (M X FS)</p>  <p>POA</p>	<p>ORFSM X ORFSF (TR) STRAIGHT (M X FS)</p>  <p>Page 31</p>	<p>ORFSM X JICF STRAIGHT (M X FS)</p>  <p>POA</p>
<p>ORFSM X ORFSF STRAIGHT (M X FS)</p>  <p>POA</p>	<p>UNOM X BSPPF STRAIGHT (M X FS)</p>  <p>Page 33</p>	<p>UNOM X JICF STRAIGHT (M X FS)</p>  <p>Page 31</p>	<p>UNOM X NPSMF STRAIGHT (M X FS)</p>  <p>POA</p>	<p>UNOM X ORFSF STRAIGHT (M X FS)</p>  <p>POA</p>

For POA please contact us

Continued on the following page...

BSPPM X BSPPF
STRAIGHT (M X FF)

POA

BSPTM X BSPTF
STRAIGHT (M X FF)

POA

BSPTM X NPTF
STRAIGHT (M X FF)

POA

BSPTM X UNOF
STRAIGHT (M X FF)

POA

JICM X BSPTF
STRAIGHT (M X FF)

POA

JICM X JICF (TE)
STRAIGHT (M X FF)

POA

JICM X NPTF
STRAIGHT (M X FF)

POA

NPTM X NPTF
STRAIGHT (M X FF)

POA

NPTM X UNOF
STRAIGHT (M X FF)

POA

ORFSM X ORFSF
STRAIGHT (M X FF)

POA

ORFSM X UNOF
STRAIGHT (M X FF)

POA

UNOM X BSPTF
STRAIGHT (M X FF)

POA

UNOM X NPTF
STRAIGHT (M X FF)

POA

UNOM X UNOF
STRAIGHT (M X FF)

POA

BSPPF X BSPPF
STRAIGHT (FS X FS)

POA

JICF X JICF
STRAIGHT (FS X FS)

POA

BSPTF X BSPPF
STRAIGHT (FF X FS)

Page 33

NPTF X JICF
STRAIGHT (FF X FS)

POA

BSPTF X BSPTF
STRAIGHT (FF X FF)

Page 34

NPTF X NPTF
STRAIGHT (FF X FF)

POA

BSPPF X BSPPF
STRAIGHT (FF X FF)

POA

UNOF X UNOF
STRAIGHT (FF X FF)

Page 33

For POA please contact us

90 Degree - M x M, M x F & F x F

<p>BSPPM X BSPPM(ADJ.) 90° ELBOW (M X M)</p> <p>Page 39</p>	<p>BSPTM X BSPPM 90° ELBOW (M X M)</p> <p>POA</p>	<p>BSPTM X BSPTM 90° ELBOW (M X M)</p> <p>Page 39</p>	<p>BSPTM X BSPTM 90° ELBOW (M X MS)</p> <p>POA</p>	<p>BSPTM X UNOM 90° ELBOW (M X M)</p> <p>Page 40</p>
<p>JICM X BSPPM 90° ELBOW (M X M)</p> <p>Page 36</p>	<p>JICM X BSPPM(EXT.) 90° ELBOW (M X M)</p> <p>POA</p>	<p>JICM X BSPTM 90° ELBOW (M X M)</p> <p>Page 36</p>	<p>JICM X BSPTM 90° ELBOW (M X MS)</p> <p>POA</p>	<p>JICM X BSPTM(EXT.) 90° ELBOW (M X M)</p> <p>POA</p>
<p>JICM X JICM 90° ELBOW (M X M)</p> <p>Page 38</p>	<p>JICM X NPTM 90° ELBOW (M X M)</p> <p>POA</p>	<p>JICM X NPTM(EXT.) 90° ELBOW (M X M)</p> <p>POA</p>	<p>JICM X UNOM 90° ELBOW (M X M)</p> <p>Page 37</p>	<p>JICM X UNOM 90° ELBOW (M X MS)</p> <p>POA</p>
<p>JICM X UNOM(EXT.) 90° ELBOW (M X M)</p> <p>Page 38</p>	<p>METRICM(DKL) X BSPTM 90° ELBOW (M X M)</p> <p>POA</p>	<p>NPTM X NPTM 90° ELBOW (M X M)</p> <p>POA</p>	<p>NPTM X UNOM 90° ELBOW (M X M)</p> <p>POA</p>	<p>ORFSM X BSPPM 90° ELBOW (M X M)</p> <p>POA</p>
<p>ORFSM X NPTM 90° ELBOW (M X M)</p> <p>POA</p>	<p>ORFSM X ORFSM 90° ELBOW (M X M)</p> <p>POA</p>	<p>ORFSM X UNOM 90° ELBOW (M X M)</p> <p>POA</p>	<p>SAEM(45°) X BSPTM 90° ELBOW (M X M)</p> <p>POA</p>	<p>UNOM X UNOM 90° ELBOW (M X M)</p> <p>POA</p>

For POA please contact us

Continued on the following page...

BSPPM(ADJ.) X JICF
90° ELBOW (M X FS)

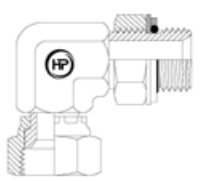

POA

BSPPM X BSPPF
90° ELBOW (M X FS)

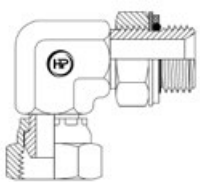

Page 42

BSPTM X BSPPF
90° ELBOW (M X FS)

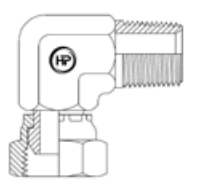

Page 42

BSPTM X JICF
90° ELBOW (M X FS)



POA

JICM X JICF
90° ELBOW (M X FS)

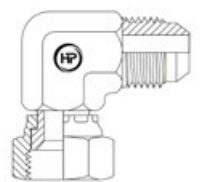

Page 41

JICM X JICF
90° BEND (M X FS)

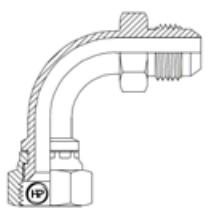

Page 41

JICM X JICF
90° LONG BEND (M X FS)

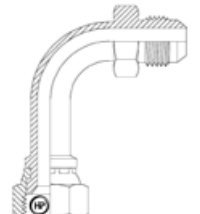

Page 41

NPTM X NPTF
90° ELBOW (M X FS)

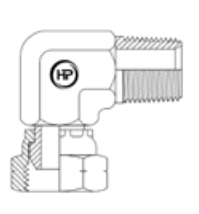

POA

ORFSM X ORFSF
90° ELBOW (M X FS)

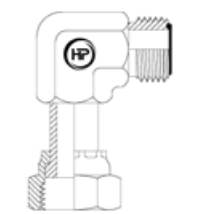

POA

SAEM X SAEF (45°)
90° ELBOW (M X FS)

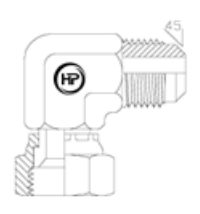

POA

UNOM X BSPPF
90° ELBOW (M X FS)

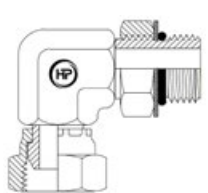

Page 42

UNOM X JICF
90° ELBOW (M X FS)

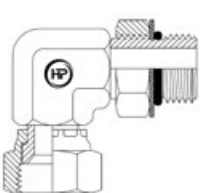

Page 40

UNOM X ORFSF
90° ELBOW (M X FS)

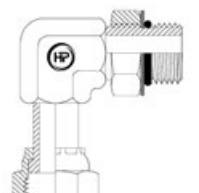

POA

BSPTM X BSPTF
90° ELBOW (M X FF)

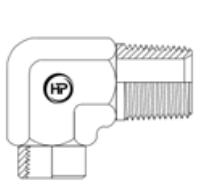

Page 43

JICM X BSPTF
90° ELBOW (M X FF)

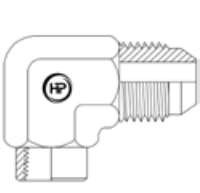

POA

JICM X NPTF
90° ELBOW (M X FF)

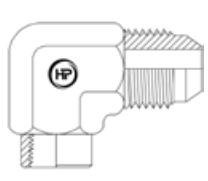

POA

NPTM X NPTF
90° ELBOW (M X FF)

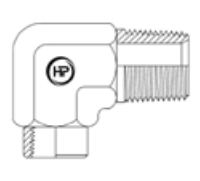

POA

UNOM X UNOF
90° ELBOW (M X FF)

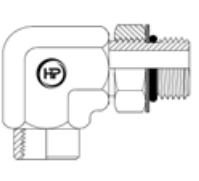

POA

BSPTF X BSPTF
90° ELBOW (FF X FF)

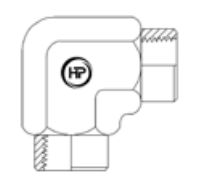

Page 43

NPTF X NPTF
90° ELBOW (FF X FF)

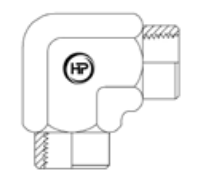

POA

45 Degree - M x M, M x F & F x F

BSPPM X BSPPM(ADJ.)
45° ELBOW (M X M)



POA

BSPTM X BSPPM(ADJ.)
45° ELBOW (M X M)



POA

BSPTM X BSPTM
45° ELBOW (M X M)



Page 46

BSPTM X UNOM
45° ELBOW (M X M)

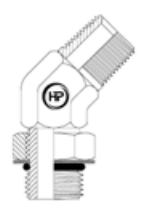

Page 47

JICM X BSPPM
45° ELBOW (M X M)



Page 45

For POA please contact us

Continued on the following page...



<p>JICM X BSPTM 45° ELBOW (M X M)</p> <p>Page 45</p>	<p>JICM X JICM 45° ELBOW (M X M)</p> <p>POA</p>	<p>JICM X NPTM 45° ELBOW (M X M)</p> <p>POA</p>	<p>JICM X UNOM 45° ELBOW (M X M)</p> <p>Page 46</p>	<p>NPTM X NPTM 45° ELBOW (M X M)</p> <p>POA</p>
<p>ORFSM X BSPPM(ADJ.) 45° ELBOW (M X M)</p> <p>POA</p>	<p>ORFSM X NPTM 45° ELBOW (M X M)</p> <p>POA</p>	<p>ORFSM X UNOM 45° ELBOW (M X M)</p> <p>POA</p>	<p>SAEM(45°) X BSPTM 45° ELBOW (M X M)</p> <p>POA</p>	<p>BSPTM X BSPTF 45° ELBOW (M X F)</p> <p>Page 48</p>
<p>JICM X JICF 45° ELBOW (M X F)</p> <p>Page 47</p>	<p>JICM X JICF 45° LONG BEND (M X F)</p> <p>Page 47</p>	<p>ORFSM X ORFSF 45° ELBOW (M X F)</p> <p>POA</p>	<p>SAEM X SAEF (45°) 45° ELBOW (M X F)</p> <p>POA</p>	<p>UNOM X JICF 45° ELBOW (M X F)</p> <p>POA</p>
<p>BSPTM X BSPTF 45° ELBOW (M X F)</p> <p>POA</p>	<p>JICM X NPTF 45° ELBOW (M X F)</p> <p>POA</p>	<p>NPTM X NPTF 45° ELBOW (M X F)</p> <p>POA</p>	<p>BSPTF X BSPTF 45° ELBOW (FF X FF)</p> <p>POA</p>	<p>NPTF X NPTF 45° ELBOW (FF X FF)</p> <p>POA</p>

Reducing Bush

<p>BSPPM X BSPPF REDUCING BUSH (M X F)</p> <p>Page 49</p>	<p>BSPTM X BSPTF REDUCING BUSH (M X F)</p> <p>Page 48</p>	<p>NPTM X NPTF REDUCING BUSH (M X F)</p> <p>POA</p>	<p>UNOM X BSPTF REDUCING BUSH (M X F)</p> <p>Page 49</p>	<p>UNOM X UNOF REDUCING BUSH (M X F)</p> <p>POA</p>
--	--	--	---	--

For POA please contact us

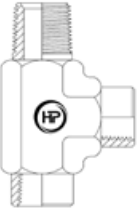
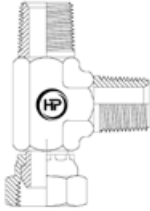
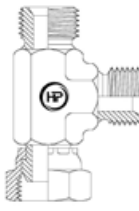
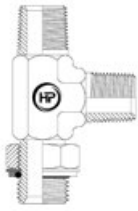
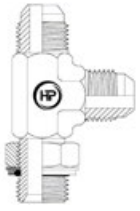
TEE - Run, Branch, Equal & Cross

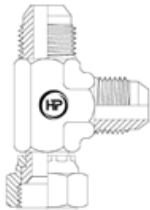
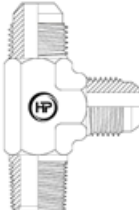
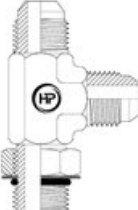
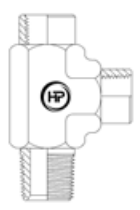
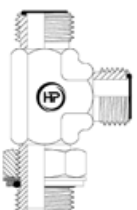
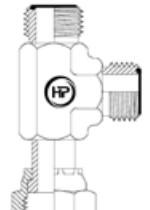
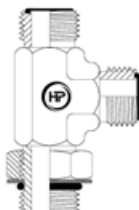
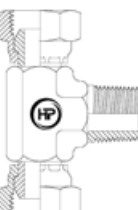
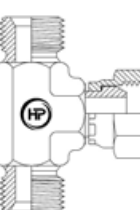
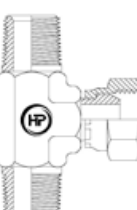
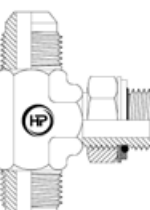
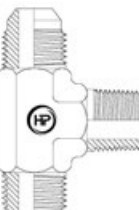
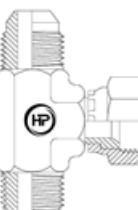
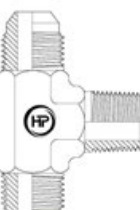
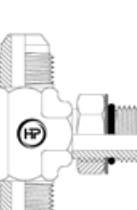
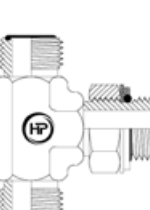
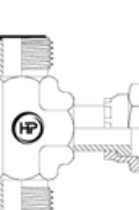
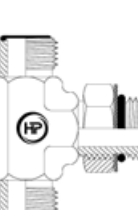
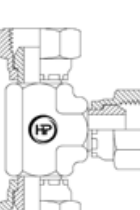
<p>BSPTM X BSPTF X BSPTF RUN TEE</p>  <p>Page 53</p>	<p>BSPTM X BSPPF X BSPTM RUN TEE</p>  <p>Page 52</p>	<p>BSPPM X BSPPF X BSPPM RUN TEE</p>  <p>Page 52</p>	<p>BSPTM X BSPPM X BSPTM RUN TEE</p>  <p>Page 52</p>	<p>JICM X BSPPM X JICM RUN TEE</p>  <p>Page 51</p>
<p>JICM X BSPTM X JICM RUN TEE</p>  <p>Page 51</p>	<p>JICM X JICF X JICM RUN TEE</p>  <p>Page 52</p>	<p>JICM X NPTM X JICM RUN TEE</p>  <p>POA</p>	<p>JICM X UNOM X JICM RUN TEE</p>  <p>Page 51</p>	<p>NPTF X NPTF X NPTM RUN TEE</p>  <p>POA</p>
<p>ORFSM X BSPPM X ORFSM RUN TEE</p>  <p>POA</p>	<p>ORFSM X ORFSF X ORFSM RUN TEE</p>  <p>POA</p>	<p>ORFSM X UNOM X ORFSM RUN TEE</p>  <p>POA</p>	<p>BSPPF X BSPPF X BSPTM BRANCH TEE</p>  <p>Page 55</p>	<p>BSPPM X BSPPM X BSPPF BRANCH TEE</p>  <p>POA</p>
<p>BSPTM X BSPTM X BSPPF BRANCH TEE</p>  <p>Page 55</p>	<p>JICM X JICM X BSPPM BRANCH TEE</p>  <p>Page 53</p>	<p>JICM X JICM X BSPTM BRANCH TEE</p>  <p>Page 54</p>	<p>JICM X JICM X JICF BRANCH TEE</p>  <p>Page 54</p>	<p>JICM X JICM X NPTM BRANCH TEE</p>  <p>POA</p>
<p>JICM X JICM X UNOM BRANCH TEE</p>  <p>Page 54</p>	<p>ORFSM X ORFSM X BSPPM BRANCH TEE</p>  <p>POA</p>	<p>ORFSM X ORFSM X ORFSF BRANCH TEE</p>  <p>POA</p>	<p>ORFSM X ORFSM X UNOM BRANCH TEE</p>  <p>POA</p>	<p>BSPPF X BSPPF X BSPPF EQUAL TEE</p>  <p>Page 56</p>

For POA please contact us

Continued on the following page...

BSPPF X BSPPF X BSPPF
EQUAL TEE

POA

BSPTF X BSPTF X BSPTF
EQUAL TEE

Page 56

BSPTM X BSPTM X BSPTM
EQUAL TEE

Page 56

JICF X JICF X JICF
EQUAL TEE

POA

JICM X JICM X JICM
EQUAL TEE

Page 55

NPTF X NPTF X NPTF
EQUAL TEE

POA

NPTM X NPTM X NPTM
EQUAL TEE

POA

ORFSM X ORFSM X ORFSM
EQUAL TEE

POA

BSPTF
CROSS TEE

POA

JICM
CROSS TEE

POA

Bulkhead - M x M

BSPPM
STRAIGHT BULKHEAD (M X M)

Page 58

JICM
STRAIGHT BULKHEAD (M X M)

Page 58

METRICM
STRAIGHT BULKHEAD (M X M)

POA

ORFS
STRAIGHT BULKHEAD (M X M)

POA

JICM(BH) X NPTM
STRAIGHT BULKHEAD (M X M)

POA

JICM(BH) X BSPPM
STRAIGHT BULKHEAD (M X M)

Page 26

JICM(BH) X BSPTM
STRAIGHT BULKHEAD (M X M)

POA

JICM(BH) X BSPTF
STRAIGHT BULKHEAD (M X FF)

POA

JICM(BH) X NPTF
STRAIGHT BULKHEAD (M X FF)

POA

JICM
90° BULKHEAD (M X M)

Page 58

ORFSM
90° BULKHEAD (M X M)

POA

JICM
45° BULKHEAD (M X M)

Page 59

ORFSM
45° BULKHEAD (M X M)

POA

JICM X JICM(BH) X JICM
TEE BULKHEAD (M X M X M)

POA

JICM X JICM X JICM(BH)
TEE BULKHEAD (M X M X M)

POA

For POA please contact us

Continued on the following page...

ORFSM X ORFSM(BH) X ORFSM
TEE BULKHEAD (M X M X M)

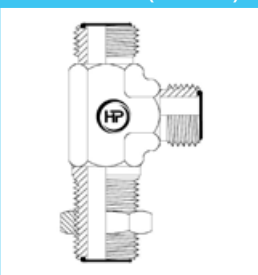

POA

ORFSM X ORFSM X ORFSM(BH)
TEE BULKHEAD (M X M X M)

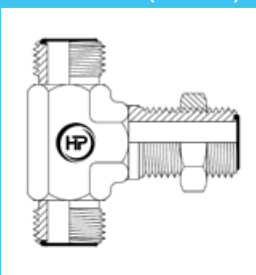

POA

Nut + Sleeve & Plugs

JIC
NUT & SLEEVE

Page 59

JIC
TUBE NUT

POA

JIC
TUBE SLEEVE

POA

ORFS
TUBE NUT

POA

BSPPM
HEX SOCKET PLUG

Page 60

BSPPM
PLUG

Page 60

BSPTM
HEX SOCKET PLUG

Page 61

BSPTM
PLUG

Page 60

JICM
PLUG

Page 59

METRICM(DKL)
PLUG

POA

METRICM(DKS)
PLUG

POA

METRICM
HEX SOCKET PLUG

POA

METRICM
PLUG

Page 62

NPTM
HEX SOCKET PLUG

POA

NPTM
PLUG

POA

ORFSM
PLUG

POA

SAEM(45°)
PLUG

POA

SAE (FLANGE)
PLUG

POA

UNOM
HEX SOCKET PLUG









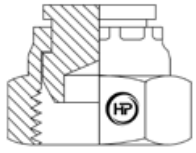
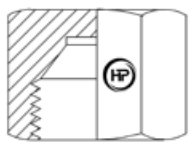
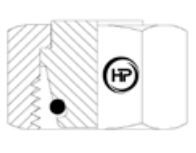
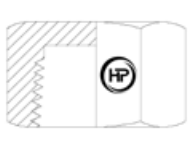
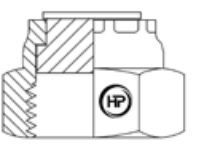

Page 61

UNOM
PLUG



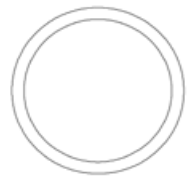



Page 61

For POA please contact us

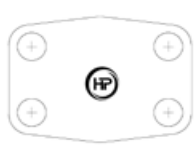
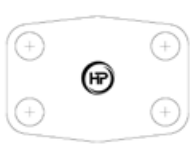
Caps, Seals & Rings

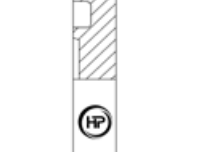
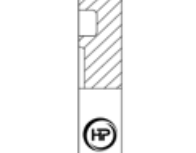



<p>BSPP CAP</p>  <p>POA</p>	<p>JIC CAP</p>  <p>POA</p>	<p>METRIC CAP</p>  <p>POA</p>	<p>NPT CAP</p>  <p>POA</p>	<p>ORFS CAP</p>  <p>POA</p>
<p>SAE (45°) CAP</p>  <p>POA</p>	<p>BSPP BONDED SEAL</p>  <p>Page 73</p>	<p>BSPP ENCAPSULATED SEAL</p>  <p>Page 73</p>	<p>METRIC BONDED SEAL</p>  <p>Page 72</p>	<p>METRIC ENCAPSULATED SEAL</p>  <p>POA</p>
<p>BSPP ADJUSTABLE O' RING</p>  <p>Page 73</p>	<p>BSPP RETAINING RING</p>  <p>Page 26</p>	<p>ORFSM O' RING</p>  <p>Page 74</p>	<p>SAE FLANGE O' RING</p>  <p>Page 74</p>	<p>UNOM O' RING</p>  <p>Page 74</p>

SAE Flange

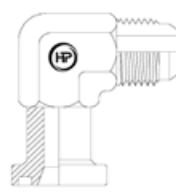
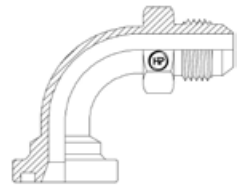
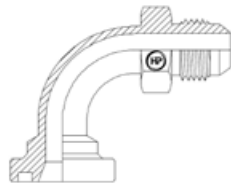
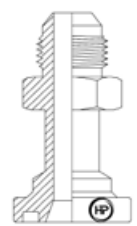
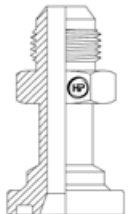

<p>CODE 61 CAP DOUBLE SIDED</p>  <p>POA</p>	<p>CODE 62 CAP DOUBLE SIDED</p>  <p>POA</p>	<p>CODE 61 ONE PIECE CLAMP</p>  <p>POA</p>	<p>CODE 62 ONE PIECE CLAMP</p>  <p>POA</p>	<p>CODE 61 PLUG</p>  <p>POA</p>
<p>CODE 62 PLUG</p>  <p>POA</p>	<p>CODE 61 SPLIT CLAMP</p>  <p>POA</p>	<p>CODE 62 SPLIT CLAMP</p>  <p>POA</p>	<p>JICM - CODE 61 45° SWEPT</p>  <p>POA</p>	<p>JICM - CODE 62 45° SWEPT</p>  <p>POA</p>

For POA please contact us

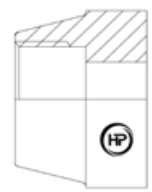
Continued on the following page...

<p>JICM - CODE 61 90° COMPACT</p>  <p>POA</p>	<p>JICM - CODE 62 90° COMPACT</p>  <p>POA</p>	<p>JICM - CODE 61 90° SWEPT</p>  <p>POA</p>	<p>JICM - CODE 62 90° SWEPT</p>  <p>POA</p>	<p>JICM - CODE 61 STRAIGHT</p>  <p>POA</p>
<p>JICM - CODE 62 STRAIGHT</p>  <p>POA</p>	<p>BSPPF (F) - CODE 61 90° COMPACT</p>  <p>POA</p>	<p>BSPPF (F) - CODE 61 90° COMPACT</p>  <p>POA</p>	<p>BSPPF (F) - CODE 61 STRAIGHT</p>  <p>POA</p>	<p>BSPPF (F) - CODE 61 STRAIGHT</p>  <p>POA</p>

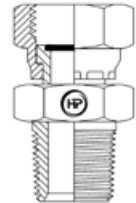
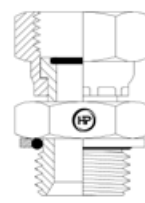
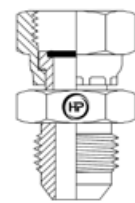
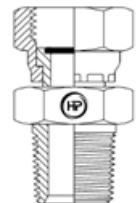
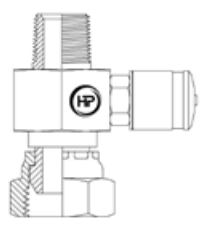
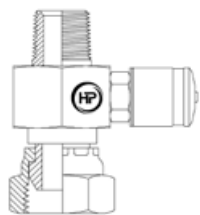
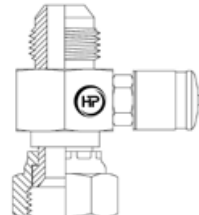
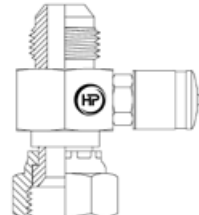
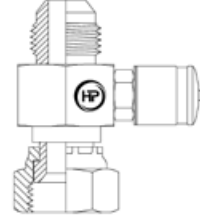
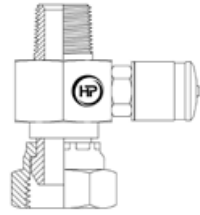
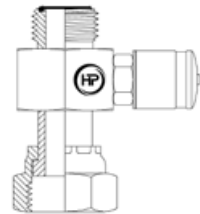
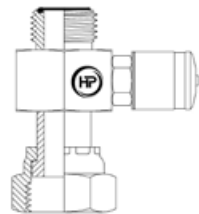
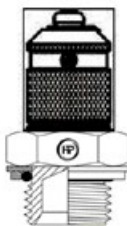
Guage Adaptor / Test Point

<p>BSPPF X BSPTM GUAGE ADAPTOR</p>  <p>POA</p>	<p>BSPPF X BSPPM GUAGE ADAPTOR</p>  <p>POA</p>	<p>BSPPF X JICM GUAGE ADAPTOR</p>  <p>POA</p>	<p>BSPPF X NPTM GUAGE ADAPTOR</p>  <p>POA</p>	<p>BSPTM X BSPPF X BSPPM CROSS PORT</p>  <p>POA</p>
<p>BSPTM X BSPPF X BSPTM CROSS PORT</p>  <p>POA</p>	<p>JICM X JICF X BSPPM CROSS PORT</p>  <p>POA</p>	<p>JICM X JICF X BSPTM CROSS PORT</p>  <p>POA</p>	<p>JICM X JICF X UNOM CROSS PORT</p>  <p>POA</p>	<p>ORFSM X ORFSF X BSPPM CROSS PORT</p>  <p>POA</p>
<p>ORFSM X ORFSF X BSPTM CROSS PORT</p>  <p>POA</p>	<p>ORFSM X ORFSF X UNOM CROSS PORT</p>  <p>POA</p>	<p>BSP TEST POINT</p>  <p>POA</p>	<p>UNO TEST POINT</p>  <p>POA</p>	<p>BSPT TEST POINT</p>  <p>POA</p>

For POA please contact us

**TECHNICAL
INFORMATION**

QUICK CONVERSION

Pressure & Imperial to Metric

Pressure Conversion

BAR	PSI	KPA	MPA	Kg/cm2
10	145	1000	1	10.2
20	290	2000	2	20.4
30	435	3000	3	30.6
40	580	4000	4	40.8
50	725	5000	5	51
60	870	6000	6	61.2
70	1015	7000	7	71.4
80	1160	8000	8	81.6
90	1305	9000	9	91.8
100	1450	10000	10	102
110	1595	11000	11	112.2
120	1740	12000	12	122.4
130	1885	13000	13	132.6
140	2030	14000	14	142.8
150	2175	15000	15	153
160	2320	16000	16	163.2
170	2465	17000	17	173.4
180	2610	18000	18	183.6
190	2755	19000	19	193.8
200	2900	20000	20	204
210	3045	21000	21	214.2
220	3190	22000	22	224.4
230	3335	23000	23	234.6
240	3480	24000	24	244.8
250	3625	25000	25	255
260	3770	26000	26	265.2
270	3915	27000	27	275.4
280	4060	28000	28	285.6
290	4205	29000	29	295.8
300	4350	30000	30	306
310	4495	31000	31	316.2
320	4640	32000	32	326.4
330	4785	33000	33	336.6
340	4930	34000	34	346.8
350	5075	35000	35	357
360	5220	36000	36	367.2
370	5365	37000	37	377.4
380	5510	38000	38	387.6
390	5655	39000	39	397.8
400	5800	40000	40	408
410	5945	41000	41	418.2
420	6090	42000	42	428.4
430	6235	43000	43	438.6
440	6380	44000	44	448.8
450	6525	45000	45	459
460	6670	46000	46	469.2
470	6815	47000	47	479.4
480	6960	48000	48	489.6
500	7250	50000	50	510

Imperial to Metric Conversion

Dash size	Inch decimal	Inch fraction	MM
-1	0.06	1/16"	1.59
-2	0.13	1/8"	3.18
-3	0.19	3/16"	4.76
-4	0.25	1/4"	6.35
-5	0.31	5/16"	7.94
-6	0.38	3/8"	9.53
-7	0.44	7/16"	11.11
-8	0.50	1/2"	12.70
-9	0.56	9/16"	14.29
-10	0.63	5/8"	15.88
-11	0.69	11/16"	17.46
-12	0.75	3/4"	19.05
-13	0.81	13/16"	20.64
-14	0.88	7/8"	22.23
-15	0.94	15/16"	23.81
-16	1.00	1"	25.40
-17	1.06	1.1/16"	26.99
-18	1.13	1.1/8"	28.58
-19	1.19	1.3/16"	30.16
-20	1.25	1.1/4"	31.75
-21	1.31	1.5/16"	33.34
-22	1.38	1.3/8"	34.93
-23	1.44	1.7/16"	36.51
-24	1.50	1.1/2"	38.10
-25	1.56	1.9/16"	39.69
-26	1.63	1.5/8"	41.28
-27	1.69	1.11/16"	42.86
-28	1.75	1.3/4"	44.45
-29	1.81	1.13/16"	46.04
-30	1.88	1.7/8"	47.63
-31	1.94	1.15/16"	49.21
-32	2.00	2"	50.80
-33	2.06	2.1/16"	52.39
-34	2.13	2.1/8"	53.98
-35	2.19	2.3/16"	55.56
-36	2.25	2.1/4"	57.15
-37	2.31	2.5/16"	58.74
-38	2.38	2.3/8"	60.33
-39	2.44	2.7/16"	61.91
-40	2.50	2.1/2"	63.50

PRESSURE DROP CHART

Hose

The figures in the chart represent the approximate pressure drop in PSI per metre length of smooth bore hose excluding fittings

Fluid specifications: Viscosity Grade = ISO 46, Specific Gravity = 0.9, Absolute Viscosity = 41.4 at 40°C

Flow Rate		1/4"		3/8"		1/2"		5/8"		3/4"		1"		1.1/4"		1.1/2"		2"	
GPM	LPM	^P	(V)	^P	(V)	^P	(V)	^P	(V)	^P	(V)	^P	(V)	^P	(V)	^P	(V)	^P	(V)
2	7.6	19.0	(13.0)	3.82	(5.8)														
3	11.4	29.0	(19.6)	5.73	(8.7)	1.8	(4.9)												
5	18.9	53.0	(32.6)	9.5	(14.5)	3.0	(8.2)	0.9	(4.5)										
10	37.9			26	(29.0)	6.4	(16.3)	1.8	(9.0)	1.2	(7.2)								
15	56.8					13.5	(24.5)	3.1	(13.4)	1.8	(11.0)	0.6	(6.12)						
20	75.7					23.0	(32.7)	5.3	(17.9)	3.2	(14.5)	0.8	(8.2)						
25	94.6							8.0	(22.0)	4.2	(18.2)	1.2	(10.2)						
30	113.6							11.0	(27.0)	6.7	(21.8)	1.7	(12.3)	0.6	(7.8)				
40	151.4									11.8	(29.0)	2.8	(16.3)	1.0	(10.5)				
50	189.3											4.3	(20.4)	1.4	(13.0)				
60	227.1											6.0	(24.5)	2.0	(15.7)	0.8	(10.9)		
70	265.0											7.9	(28.6)	2.7	(18.3)	1.1	(12.7)	0.3	(7.1)
80	302.8											10.0	(32.7)	3.4	(20.9)	1.4	(14.5)	0.4	(8.2)
100	378.5													5.0	(26.0)	2.1	(18.0)	0.5	(10.2)
150	567.8															4.3	(27.2)	1.1	(15.3)
200	757.0																	1.8	(20.4)
300	1135.5																	3.7	(30.6)

^P = Pressure Drop in PSI
V = Velocity in Ft/Sec

Example

10m of 6G2

Oil flow rate of 5 GPM = 9.5 (^P)

m x P = Pressure Drop

10 x 9.5 = 90.50m psi @ 5GPM

FLOW RATE

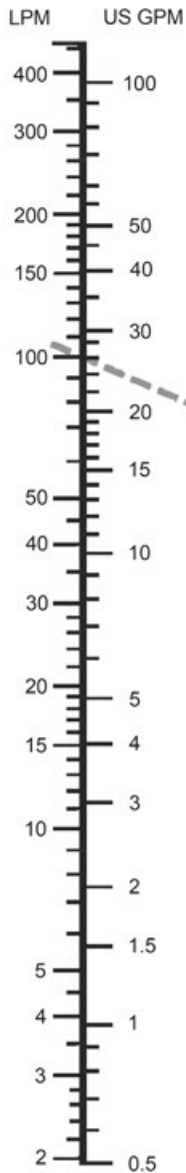

HOSE BORE

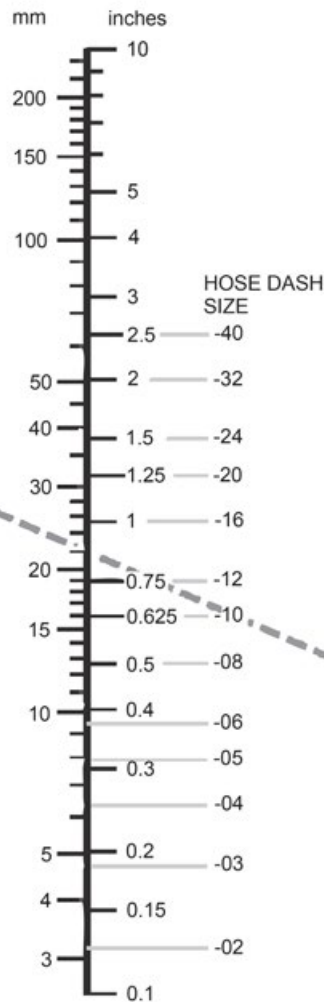

FLOW VELOCITY

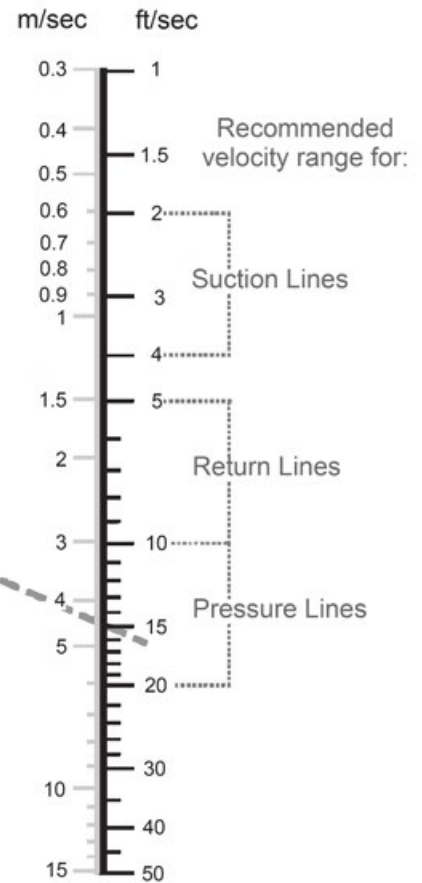

Using any two known factors lay a ruler across to find the value of the unknown factor line

Hose Assembly Length

Unless otherwise specified, assembly length shall be the overall length measured from the extreme end of one connector to the extreme end of the other. Where elbow connectors are used, measurement shall be the centerline of the fitting.

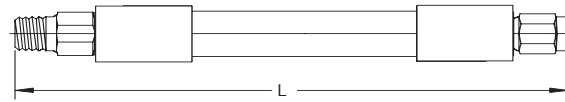

Straight connectors

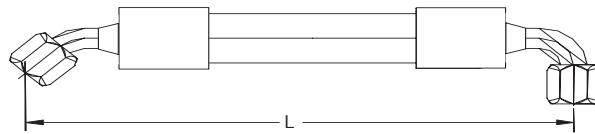

Female swivel elbow connectors

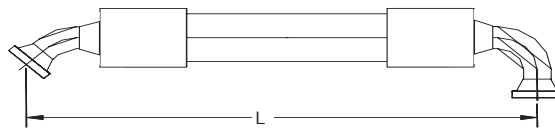

Flange connectors

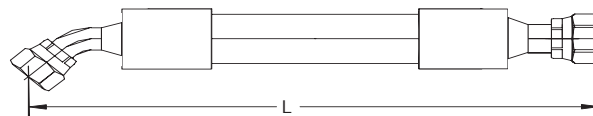

Straight and elbow connectors

How to determine Angular Orientation

When a hose assembly has an elbow connection at each end, it will be necessary to check the offset position of the connections relative to each other.

This can be done by positioning the farthest connection vertically up (or down) and viewing the assembly in a line of sight position, the offset can then be measured in a clockwise direction through the centre of the farthest end to the centre of the nearest end.

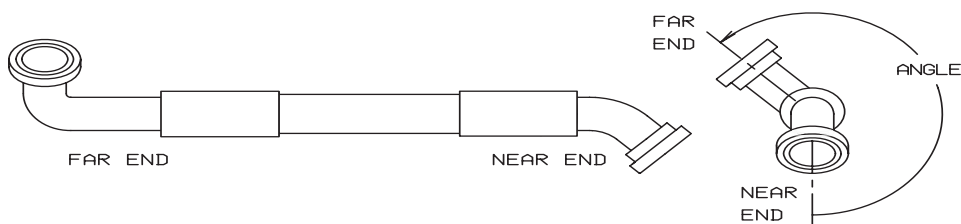

CONNECTOR PRESSURE TABLES

JIC, BSPP, BSPT, SAE

IMPORTANT NOTICE

The pressures specified in this document are to be used as a guide only, not as a standard, specification or guaranteed minimum.

Many factors influence the pressure at which a system will operate. These factors include torque settings, alignment, vibration, external environment, correctness of installation, alignment, adequate support, temperature limits, pressures and pulses.

The Maximum Rated Working Pressure on an assembly or installation is the Maximum Rated Working Pressure of the component/connection with the least rating.

JIC				
Dash	Male		Female	
	Bar	PSI	Bar	PSI
07	480	7000	480	7000
08	480	7000	480	7000
09	345	5000	345	5000
12	275	4000	275	4000
14	260	3800	260	3800
17	240	3500	240	3300
21	225	3000	225	3500
26	170	2500	170	2500
30	145	2100	145	2100
40	120	1750	120	1750

BSPP						
DASH	Male - Encapsulated		Male Adjustable		Female - Swivel	
	Bar	PSI	Bar	PSI	Bar	PSI
02	600	8700	275	4000	550	8000
04	600	8700	275	4000	550	8000
06	600	8700	275	4000	520	7500
08	400	6000	275	4000	380	5500
12	400	6000	170	2500	275	4000
16	400	6000	170	2500	240	3500
20	380	5500	140	2000	200	3000
24	380	5500	140	2000	175	2500
32	250	3500			140	2000

BSPT

Dash	Male - Fixed		Male - Swivel		Female - Fixed	
	Bar	PSI	Bar	PSI	Bar	
02	690	10000			550	
04	650	9500	260	3750	550	
06	550	8000	200	3000	520	
08	410	6000	170	2500	380	
10	340	5000	170	2500	275	
12	340	5000	170	2500	275	
16	275	4000			240	
20	200	3000			200	
24	140	2000			175	
32	140	2000			140	

NPT

Dash	Male - Fixed		Male - Swivel		Female - Fixed	
	Bar	PSI	Bar	PSI	Bar	PSI
02	690	10000			550	8000
04	650	9500	260	3750	550	8000
06	550	8000	200	3000	520	7500
08	410	6000	170	2500	380	5500
12	340	5000	170	2500	275	4000
16	275	4000			240	3500
20	200	3000			200	3000
24	140	2000			175	2500
32	140	2000			140	2000

SAE

Dash	CD61		CD62	
	Bar	PSI	Bar	PSI
08	345	5000	410	6000
12	345	5000	410	6000
16	345	5000	410	6000
20	275	4000	410	6000
24	205	3000	410	6000
32	205	3000	410	6000

JIS

Dash	Male		Female	
	Bar	PSI	Bar	PSI
14 (M)	450	6500	410	6000
16 (M)	450	6500	410	6000
22 (M)	410	6000	380	5500
24 (M)	345	5000	310	4500
30 (M)	275	4000	260	3750

CRIMP CHARTS

Hose

One Wire

R1AT 1SN		One Piece	Two Piece
Dash	Size	mm	mm
04	1/4"	17.3	18.4
05	5/16"		19.5
06	3/8"	21.5	21.6
08	1/2"	25	23.6
10	5/8"	28.3	27.2
12	3/4"	31.8	30.8
16	1"	40.5	39.4

Two Wire

R2AT 2SN		One Piece	Two Piece
Dash	Size	mm	mm
04	1/4"	18.3	19.4
05	5/16"	19.8	20.5
06	3/8"	22.5	22.2
08	1/2"	26.0	24.6
10	5/8"	29.2	28.2
12	3/4"	32.7	31.8
16	1"	41.5	40.4

QUALITY

With **HYDPOWER'S** Hose & fittings range you can be rest assured that all of our products listed in this catalogue have been thoroughly tested within the performance parameters of the relevant hose types we supply. To obtain optimum performance from our hose & fittings, all connections should be made in accordance with any technical data we produce. All our products are manufactured to global industry standards and come with an industry leading 24 month no quibble warranty.

COMPATIBILITY

It is important to not mix & match hydraulic hose supplied by us with fittings from another manufacturer. It is the responsibility of the hose assembly fabricator to consult the manufacturers assembly instructions before intermixing hose & fittings from two different manufacturers. We accept no responsibility if these guidelines are not followed.

DISTRIBUTION

We understand that when you order products from us, you need them quickly. We pride ourself on our accurate product selection and timely distribution. We will pick your parts right first time and get them out to you as fast as possible using our shipping & courier network. Our comprehensive ordering & despatch system ensures that your orders are correct before leaving us.

WHAT YOU CAN EXPECT

Differentiation - Both product manufacture and quality control are under direct and daily supervision of first class team here in Australia. All products are checked and packed in our factory before being shipped directly to you.

Logistics Support - We are experts in receiving, breaking down shipments and on-forwarding customer orders to the point of supply. This minimises logistic costs, handling points and lead time for you.

Supply chain connection - With our advanced, in house developed cloud-based logistics system, we're able to interact with you directly, taking care of the complete supply chain process from start to finish.

Cost-effective convenience - You have the advantage of dealing with a quality supplier at a low-cost base. The efficiency of our supply chain processes adds to the cost effectiveness.

Peace of mind - Our aim is to save you time, money and stress. We deal with all the detail associated with supply (quality control, importing, minimum order quantities and more) while providing seamless communication with you. The process is effortless for you and gives you the security and convenience of dealing with a wholly owned Australian company. It frees you up to do what you do best.

Contact us today to find out how **HYDPOWER** can work with your company to supply and deliver quality products.

DISCLAIMER

We reserve the right to alter the design or discontinue any of the company's products or services without notice. Whilst every effort has been made to ensure the accuracy of the information in this catalogue, it may be necessary to make changes that aren't reflected in this publication. All illustrations are not to scale and are indicative of type only.

© Hydpower Hydraulics 2020

TERMS & CONDITIONS

STANDARD CONDITIONS OF SALE "Hydpower Hydraulics" means Hydpower Hydraulics Pty Ltd A.B.N 27 129 361 315 and all related corporations, successors and assigns;

"Contract" means the contract referred to in Clause 2;

"Customer" means a person or entity acquiring or offering to acquire Products from Hydpower Hydraulics and, where the Customer comprises more than one party, the covenants and obligations of each party are joint and several;

"Products" mean all products, services and equipment supplied or to be supplied by Hydpower Hydraulics to the Customer;

"Conditions" means these Standard Conditions of Sale.

1. APPLICATION OF CONDITIONS

Unless otherwise agreed in writing by Hydpower Hydraulics, these Conditions will apply to all quotations, orders and offers in relation to the Products and the sale, supply, service and replacement of all Products and will take precedence over any inconsistent provisions in any Customer order or contained or referred to elsewhere or implied by trade custom, practice or course of dealing.

2. ORDERS AND CONTRACT

2.1 Each order by a Customer is deemed to be an offer to the Company under these Conditions and is not binding on Hydpower Hydraulics prior to Hydpower Hydraulics acceptance of it. On Hydpower Hydraulics written acceptance of an order, the order and these Conditions will constitute the entire agreement of the parties in relation to the subject of that order (the "Contract") and may only be varied in writing, signed by the parties.

2.2 Acceptance by the Customer of possession and/or delivery of Products will constitute acceptance or confirmation of previous acceptance of these Conditions to be exclusion of all other terms or provisions.

2.3 The Customer is not entitled to cancel any order or materially vary any specifications without Hydpower Hydraulics previous consent in writing.

3. QUOTATIONS AND PRICES

3.1 Prices quoted by Hydpower Hydraulics are firm for a period of 28 days from the date of quotation.

3.2 Hydpower Hydraulics reserves the right to make any changes necessary to correct errors or allow for increases in the cost of labour, materials, freight, foreign exchange rates, taxes, duty or other levies taking effect prior to the date of delivery.

3.3 Unless otherwise stipulated, the quoted price is exclusive of all taxes and duties, transit insurance and transportation costs and charges of any other kind, for which the Customer will also be liable.

4. CREDIT

Hydpower Hydraulics reserves the right to withdraw credit at any time and substitute cash with order or cash on delivery or any other terms. Hydpower Hydraulics may refuse to proceed with any Contract at any time if the Customer's credit is/or becomes unsatisfactory to Hydpower Hydraulics.

5. DESCRIPTION

5.1 Hydpower Hydraulics catalogues, price lists and quotations do not constitute offers. Any description of Products given by Hydpower Hydraulics is for identification purposes only and does not constitute the Contract of sale by description.

5.2 All drawings, designs, specifications and particulars of weight, dimensions and any figures or statements as to the performance of the Products issued by Hydpower Hydraulics are intended merely to describe the Products generally and are not to be regarded as warranty, representation or contractual term unless expressly agreed by Hydpower Hydraulics in writing.

6. TITLE AND RISK

6.1 Notwithstanding any arrangements made for the transportation of the Products to the Customer's nominated destination, all Products sold are at the risk of the Customer from the time the Products leave Hydpower Hydraulics premises.

6.2 Regardless of the point at which risk in the Products passes to the Customer, Products remain the property of the Company as legal and equitable owner and no property in or title to any Products supplied with pass to the Customer until payment has been made (and all cheques and other negotiable instruments have been cleared) for all Products supplied by Hydpower Hydraulics to the Customer. Pending legal and beneficial ownership of the Products passing to the Customer, the Customer must: - 1. Keep the Products in good condition; 2. keep the Products fully insured to their full replacement value against all risks; 3. not encumber the Products in any way; and iv. hold and keep the Products separately from other property in the possession of the Customer in a manner which enables the products to be easily identifiable as Products supplied by Hydpower Hydraulics.

6.3 Failure to make any payment to Hydpower Hydraulics by the due date will, without prejudice to any other available remedies, entitle Hydpower Hydraulics to repossess the Products from any premises where they may be situated. For the purpose of repossessing the Products, the customer hereby grants and irrevocable licence to Hydpower Hydraulics, its employees or agents, to enter upon such premises as Hydpower Hydraulics reasonable suspects the Products may be located, using such reasonable force as is necessary and the Customer will indemnify the Company from and against any liability to any third party in respect of any such damage and from and against all actions, proceedings, claims, demands, costs, damages and expenses howsoever arising.

6.4 Hydpower Hydraulics will be entitled to bring an action against the Customer for the price of the Products in the event of non-payment by the Customer by the due date as if the property in the Products had already passed to the Customer and will also have the right by notice in writing to the Customer at any time after the agreed delivery date to pass the property in the Products to the Customer as from the date of such notice.

7. CLAIMS

7.1 Return of Products will not be accepted unless: - 1. Hydpower Hydraulics has received a substantiated written claim within 14 days from the date of delivery; 2. Prior authorisation has been given by the Company; 3. On return, the Products are accompanied by appropriate documentation which stipulates the invoice number, the Customer name and address and the reasons for return; iv. The Products are faulty by reason only that the quality of materials used for the construction of the Products or the manufacturing process was defective.

For comprehensive details please see our website for details.



contact the **HYDPOWER** team today

P: 1300 730 198 | (03) 5975 0885

E: sales@hydpower.com.au

W: hydpower.com.au

A: 2/9 Fuji Cres, Mornington, Vic, 3931